



**DISCLAIMER**  
 THE USE OF AND RELIANCE UPON THIS RECORDED-DATA BY THE HEREIN NAMED COMPANY (AND ANY OF ITS AFFILIATES, PARTNERS, REPRESENTATIVES, AGENTS, CONSULTANTS AND EMPLOYEES) IS SUBJECT TO THE TERMS AND CONDITIONS AGREED UPON BETWEEN SCHLUMBERGER AND THE COMPANY, INCLUDING: (a) RESTRICTIONS ON USE OF THE RECORDED-DATA; (b) DISCLAIMERS AND WAIVERS OF WARRANTIES AND REPRESENTATIONS REGARDING COMPANY'S USE OF AND RELIANCE UPON THE RECORDED-DATA; AND (c) CUSTOMER'S FULL AND SOLE RESPONSIBILITY FOR ANY INFERENCE DRAWN OR DECISION MADE IN CONNECTION WITH THE USE OF THIS RECORDED-DATA.

**OTHER SERVICES1**  
 OS1: FMS  
 OS2: MSS  
 OS3: HRLA/HLDS/APS/HNGS  
 OS4:  
 OS5:

**OTHER SERVICES2**  
 OS1:  
 OS2:  
 OS3:  
 OS4:  
 OS5:

**REMARKS: RUN NUMBER 1**  
 Hole drilled with RCB coring bit and bottom hole assembly (BHA). 9 7/8 " BS  
 FMS/DSI run bridged at 471mbsf.  
 Uplog 1 SAM1,LFDSAM2,SAM4 LFD (Low Frequency)  
 Uplog 2 SAM1LFD,2,4 MFD (medium Frequency)  
  
 Dipole sonic data requires processing with Geoframe BestDT for best results.  
 2 MCD (mechanical Caliper Device) centralizers run with FMS/DSI.  
 Downlog utilized SAM1 LFD, SAM2, SAM4 standard frequency which is not presented but recorded separately.  
  
 The RCB bit was dropped at the bottom of the hole prior to logging.  
  
 Logs originally recorded in meters below rig floor but changed to meters below sea floor in playback

**REMARKS: RUN NUMBER 2**

RUN 1		
SERVICE ORDER #:		
PROGRAM VERSION:	19C0-187	
FLUID LEVEL:		
LOGGED INTERVAL	START	STOP

RUN 2		
SERVICE ORDER #:		
PROGRAM VERSION:		
FLUID LEVEL:		
LOGGED INTERVAL	START	STOP

## EQUIPMENT DESCRIPTION



**RUN 1**

**SURFACE EQUIPMENT**

GSR-U 616008  
 WITM (EDTS)-A

**RUN 2**

**DOWNHOLE EQUIPMENT**

LEH-MT 101	MDSB_EDTC		34.55	
LEH-MT 101 101	Mud Tempe		33.49	
	CTEM		32.92	34.55
EDTC-B	Gamma Ray			
EDTH-B 8303	EFTB DIAG			
EDTC-B 8317	TelStatus			
EDTG-A/B 8305	EDTCB Ele		32.57	
			31.87	32.57

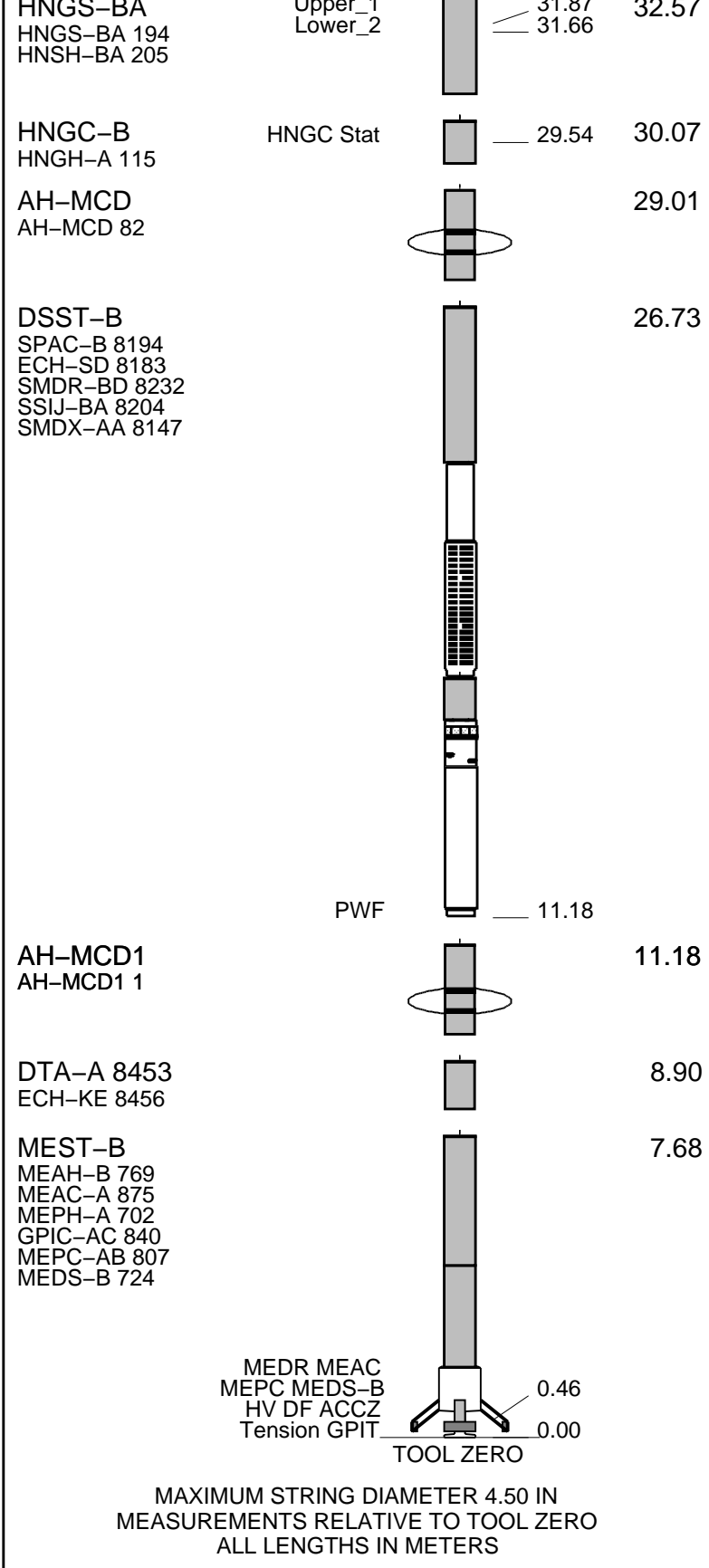

MAXIMUM STRING DIAMETER 4.50 IN  
MEASUREMENTS RELATIVE TO TOOL ZERO  
ALL LENGTHS IN METERS

Production String	(in)	(M)	Well Schematic	(M)	(in)	Casing String
	OD	ID		MD	MD	

Kelly Bushing Elevation  
Derrick Floor Elevation  
  
Mean Sea Level

-425  
-425  
  
-4240

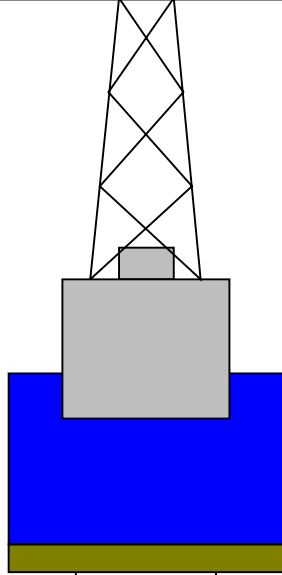

4.1



0      4.1  
149.6    9.875  
  
1008.8

Sea Floor  
Open Hole  
  
Total Depth

**Input DLIS Files**

DEFAULT	FMS_DSI_NGS_037PUP	FN:59	PRODUCER	18-Feb-2014 04:12	4702.3 M	4242.8 M
---------	--------------------	-------	----------	-------------------	----------	----------

**Output DLIS Files**

DEFAULT	FMS_DSI_NGS_061PUP	FN:81	PRODUCER	17-Mar-2014 14:43	451.1 M	-8.2 M
---------	--------------------	-------	----------	-------------------	---------	--------

**OP System Version: 19C0-187**

MEST-B	19C0-187	DTA-A	8453
DSST-B	19C0-187	HNGC-B	19C0-187
HNGS-BA	19C0-187	EDTC-B	SKK-5169-EDTCB

**PIP SUMMARY**

Time Mark Every 60 S

<b>HNGS Spectroscopy Gamma Ray (HSGR)</b>		
0	(GAPI)	100
<b>Waveform Data Copy Indicator 4 - Monopole P&amp;S (WCI4)</b>		
0	(-----)	10
<b>Peak Coherence / RA - P &amp; S Shear (CHRS)</b>		
-1	(-----)	9

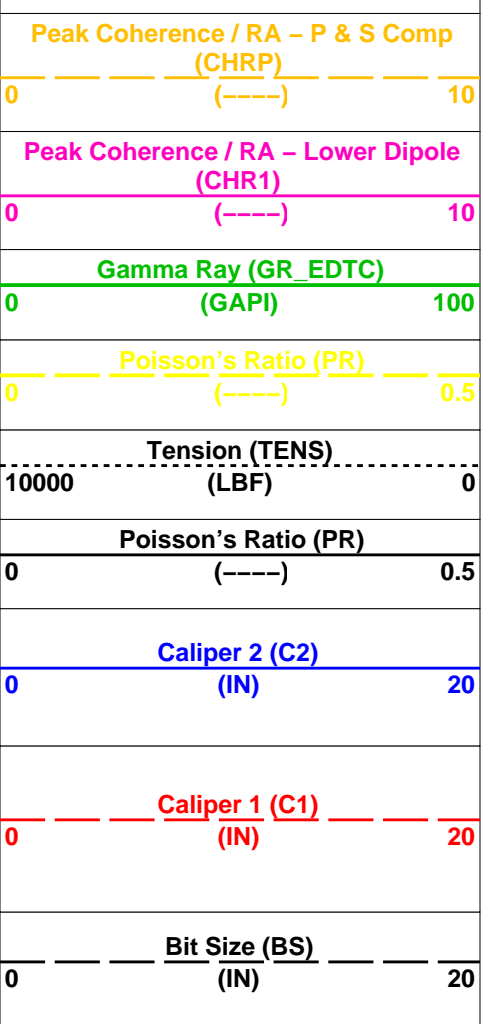

SAM1 LFD, SAM2, SAM4 MFD

2nd Pass, Sea Floor Depth Reference

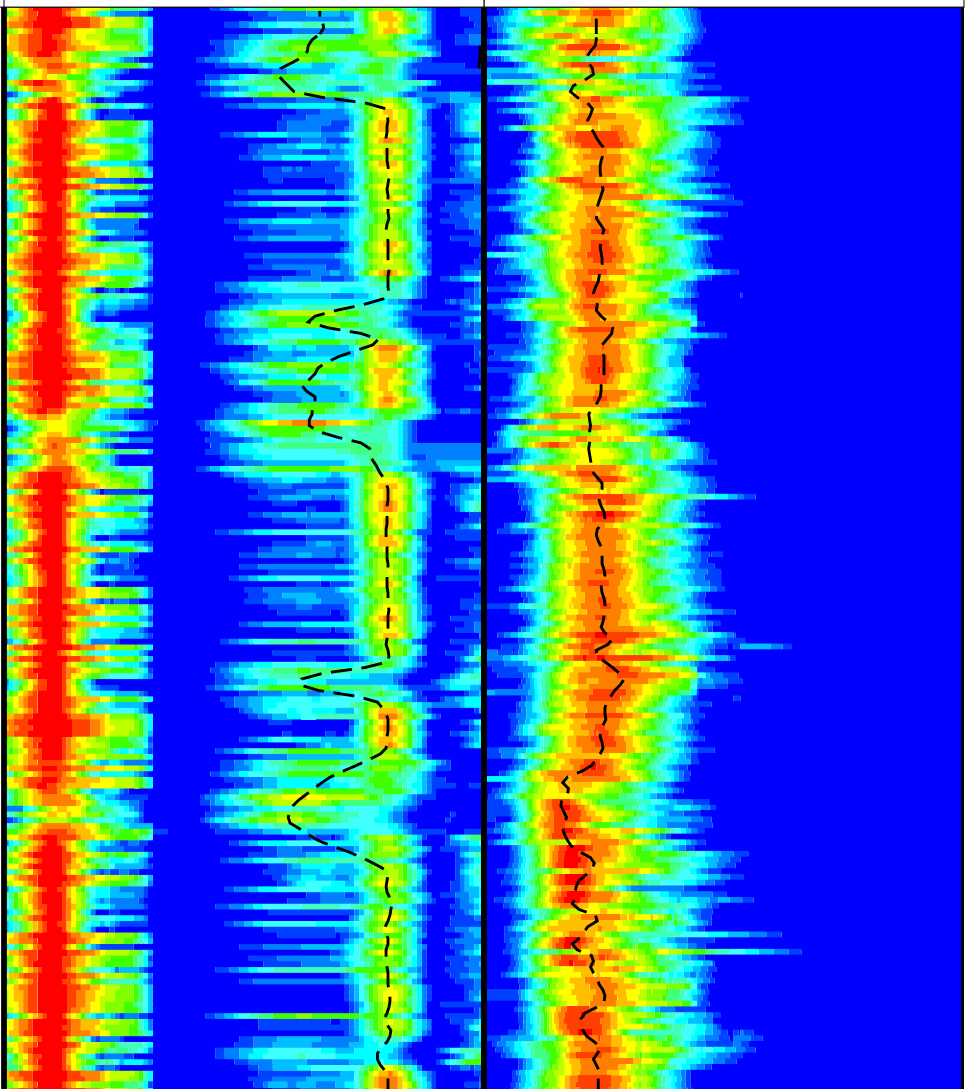
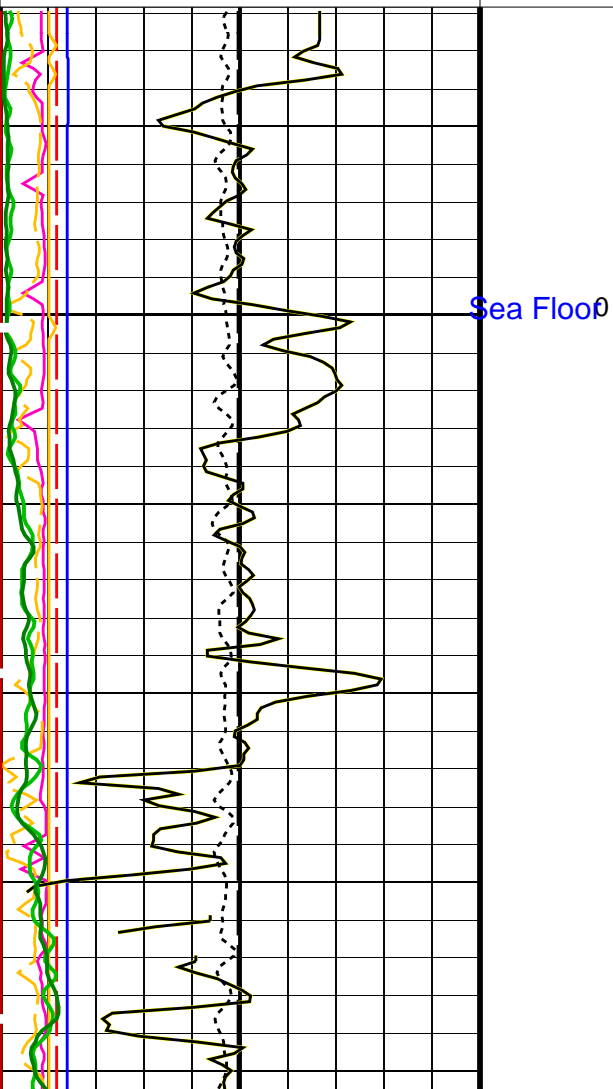
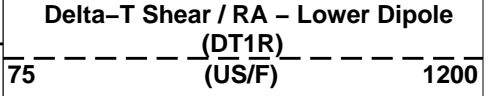
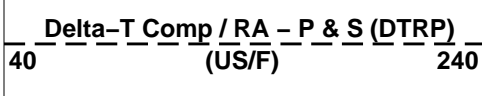
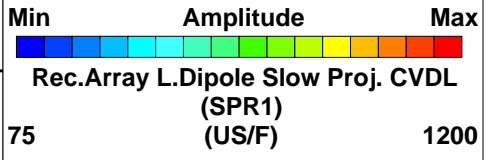
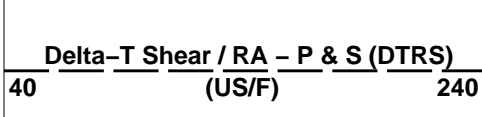
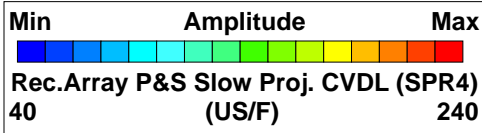

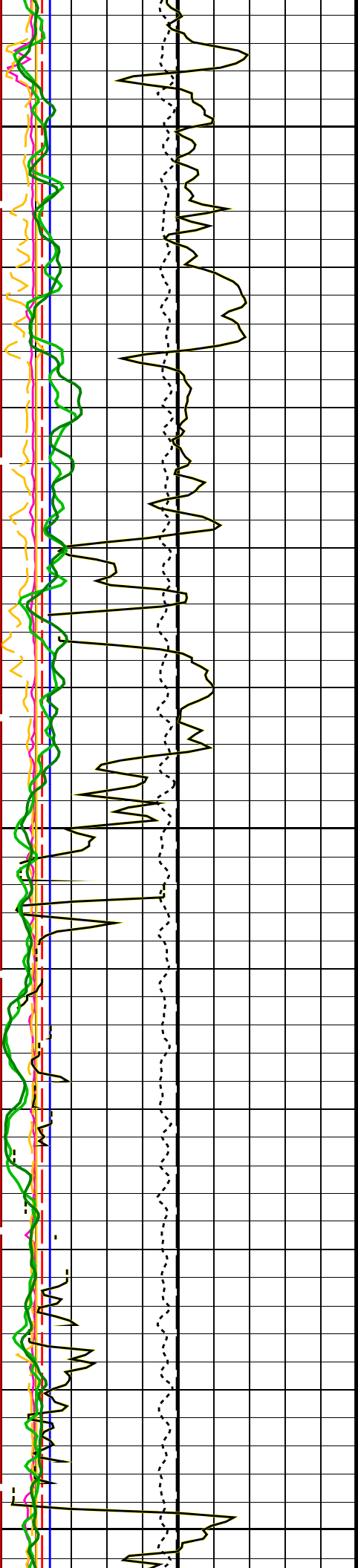

25

50

75

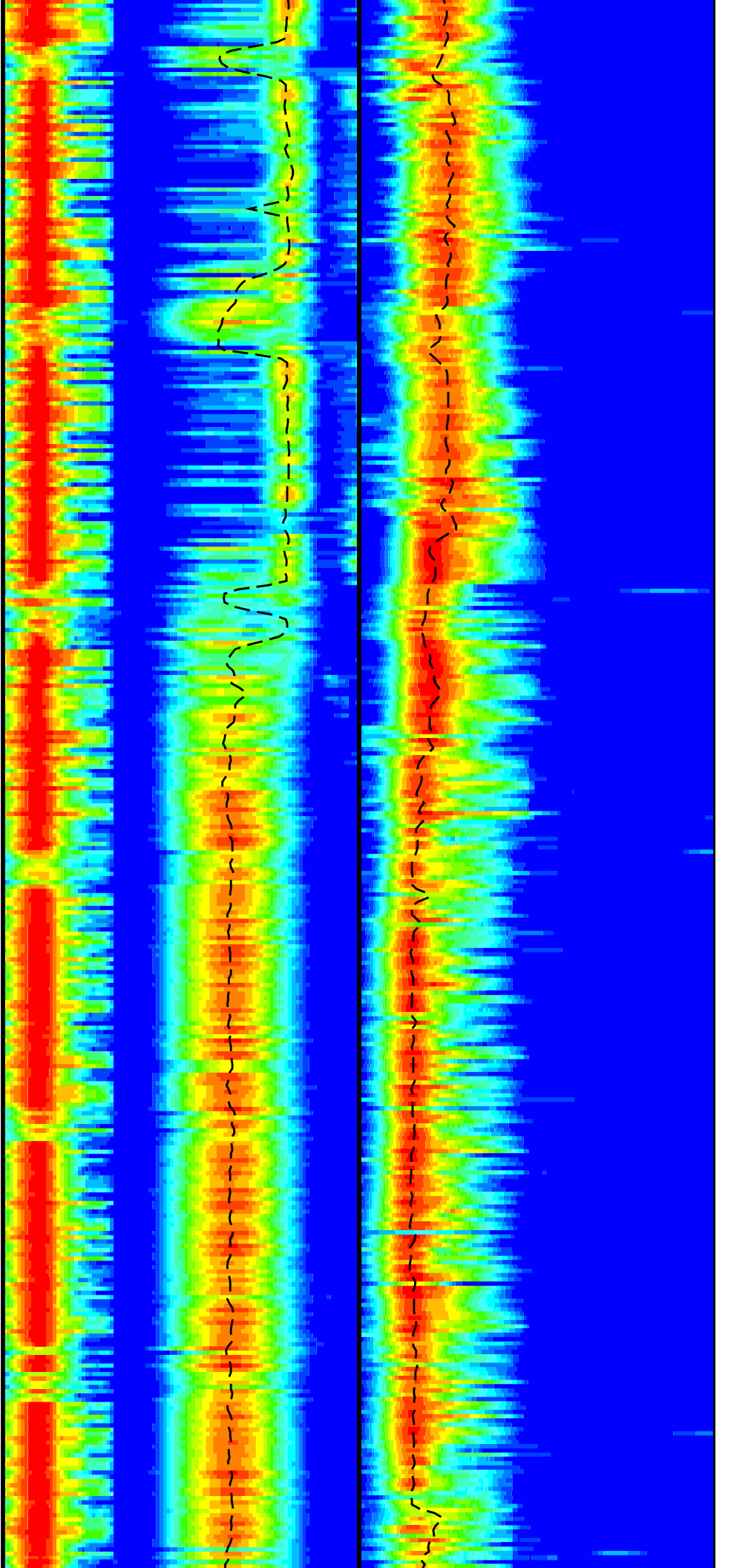

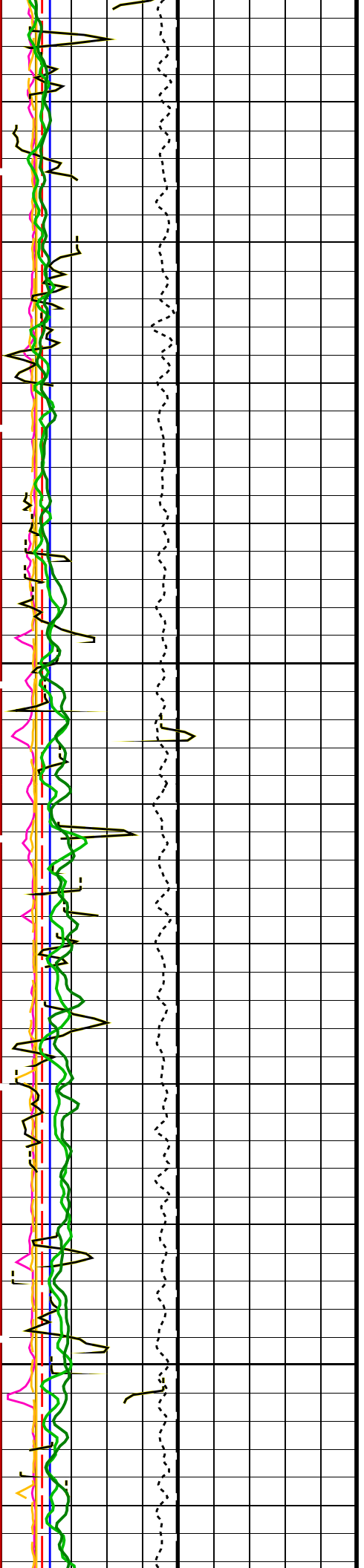

100

125

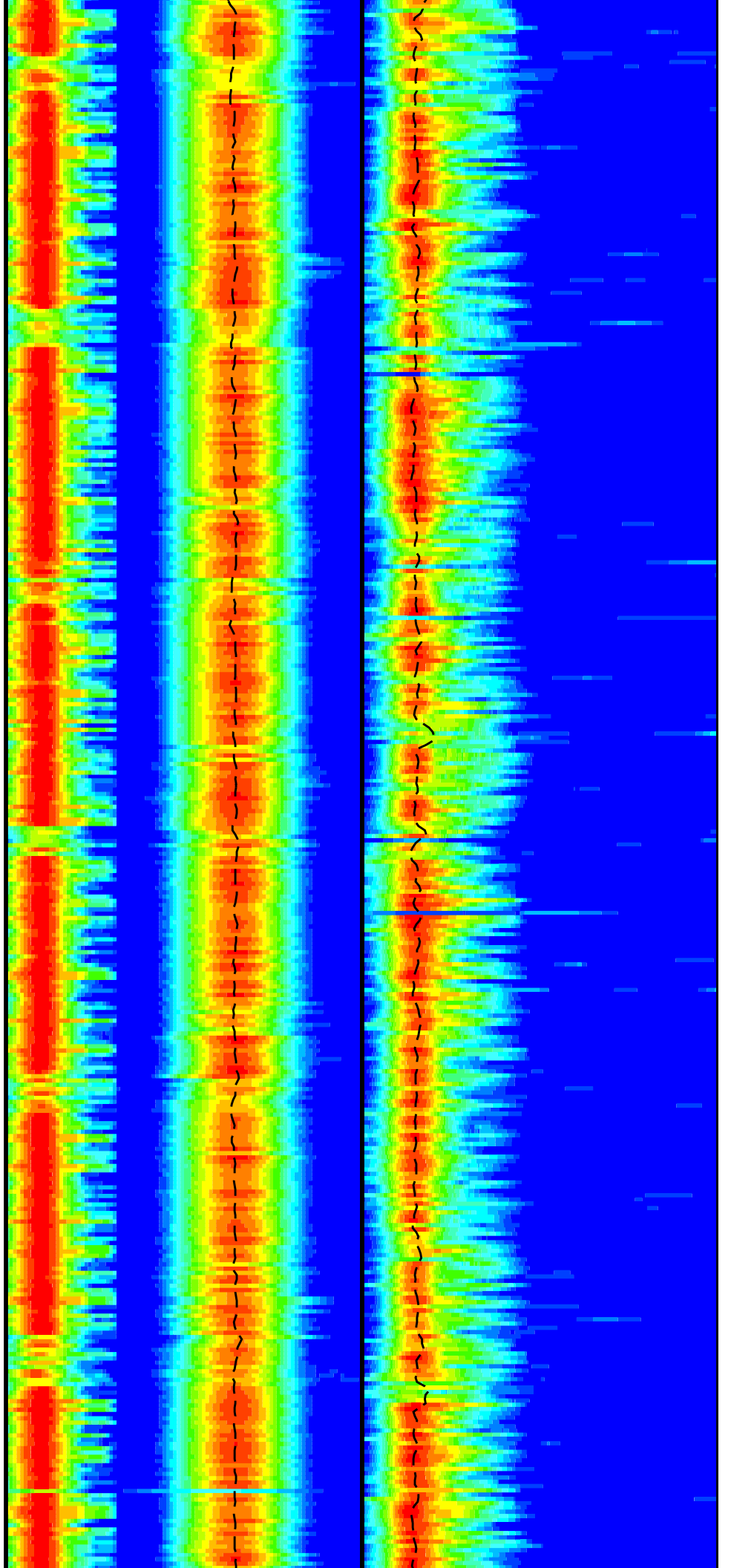



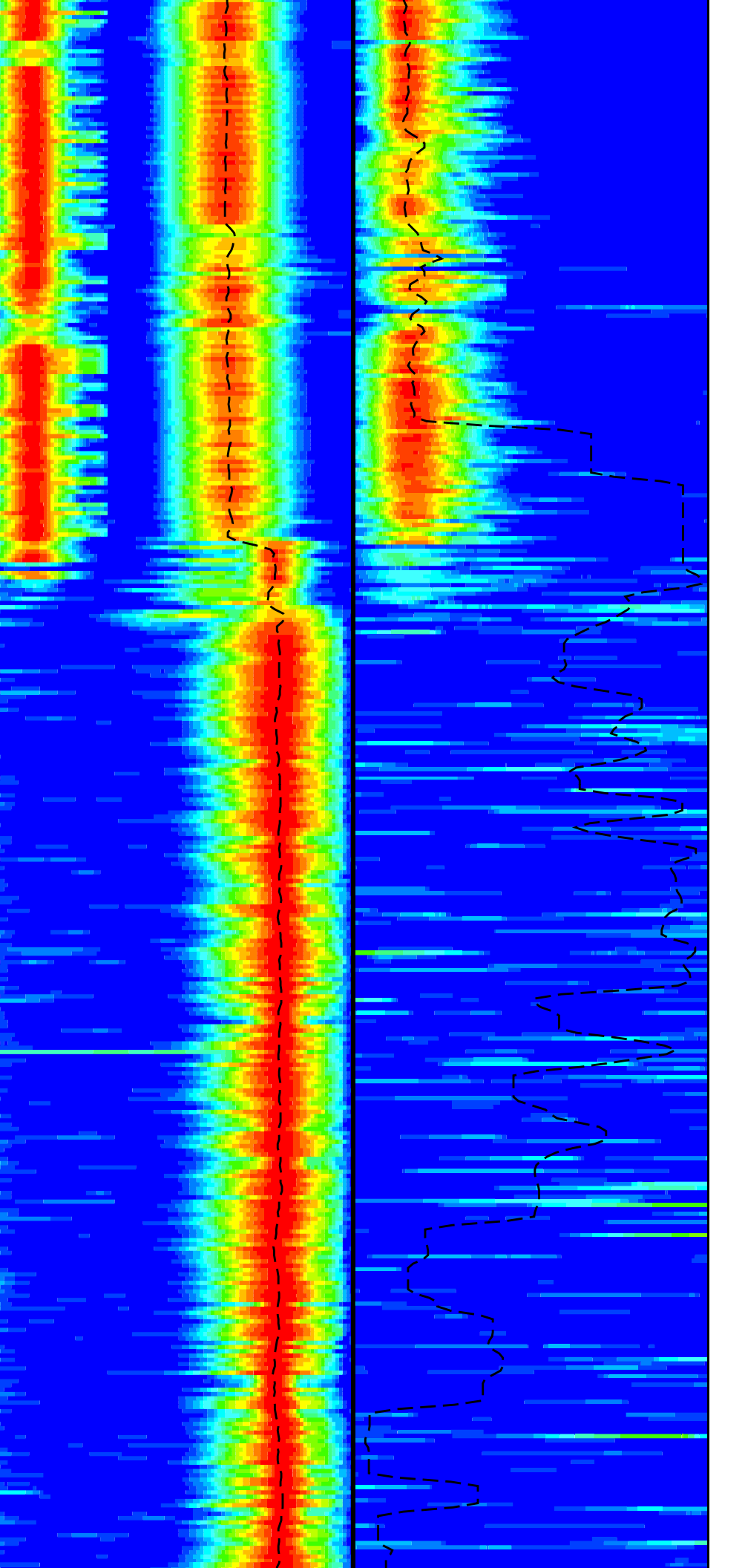
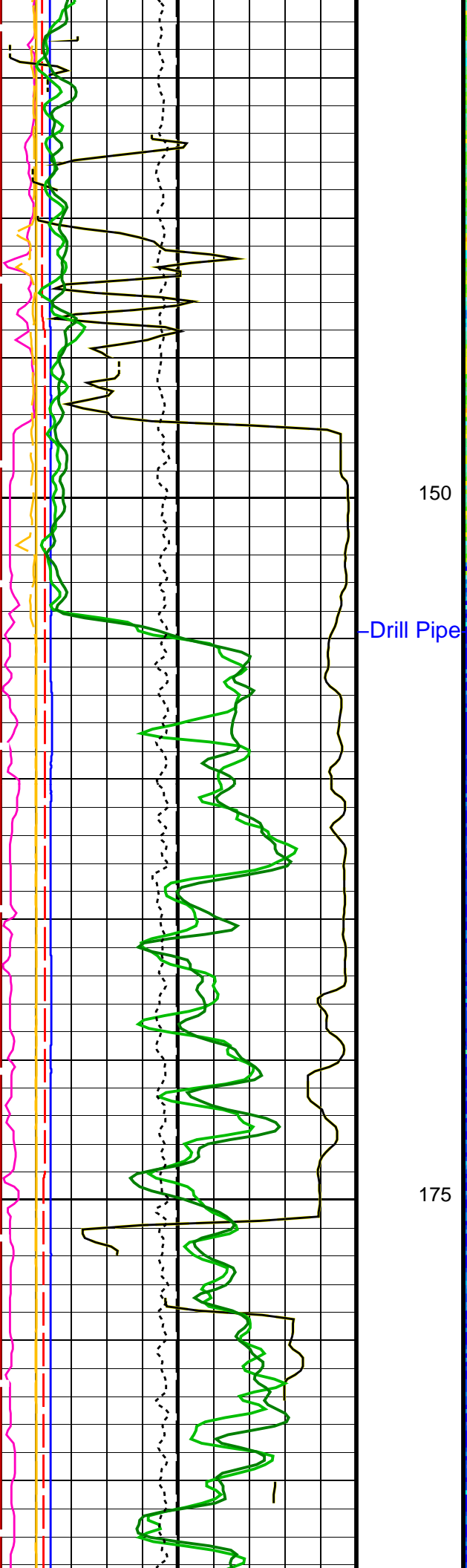

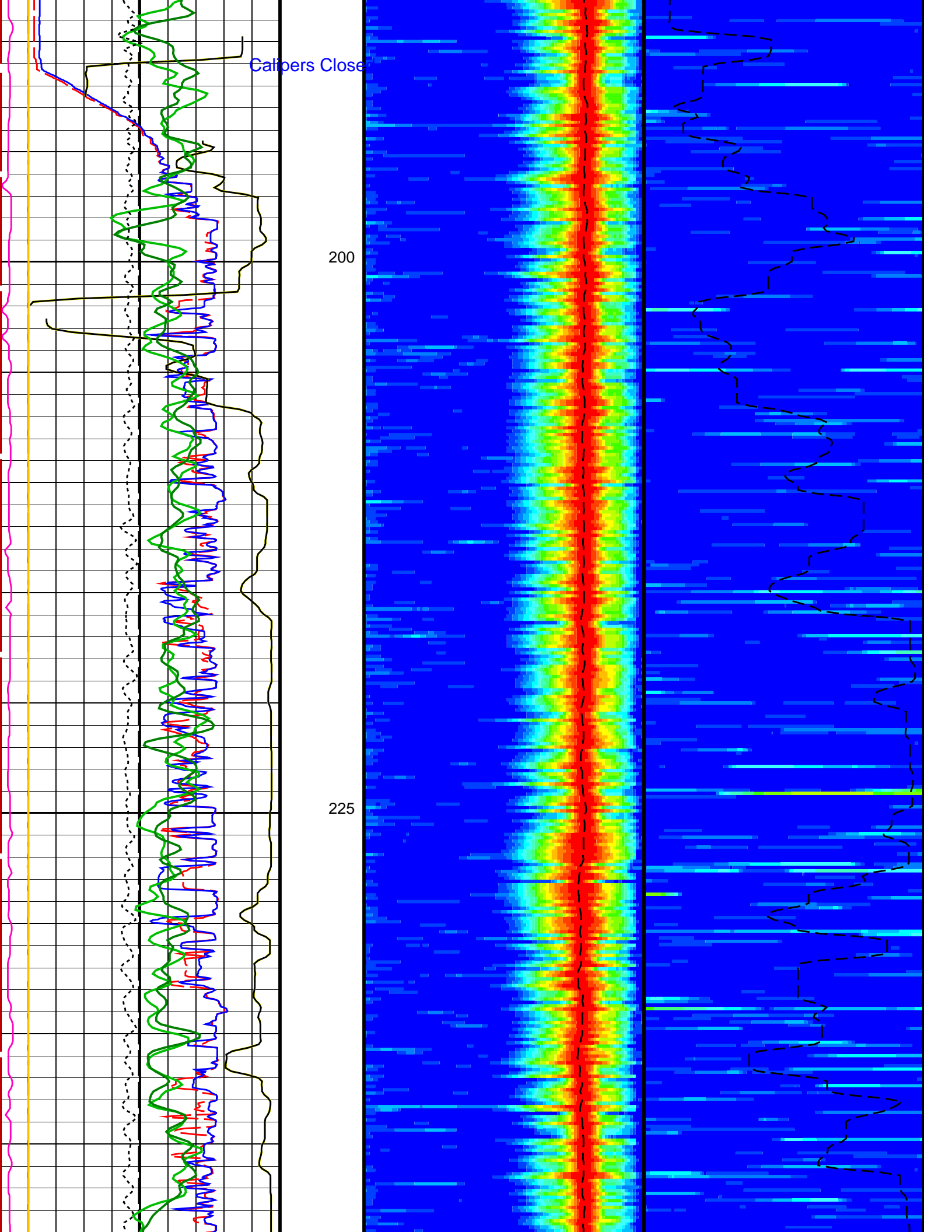

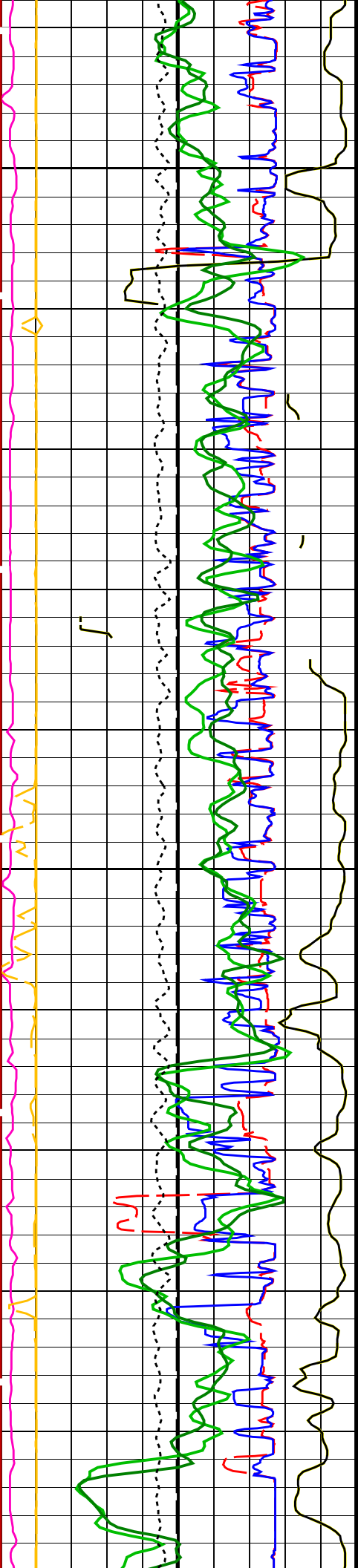

250

275

300

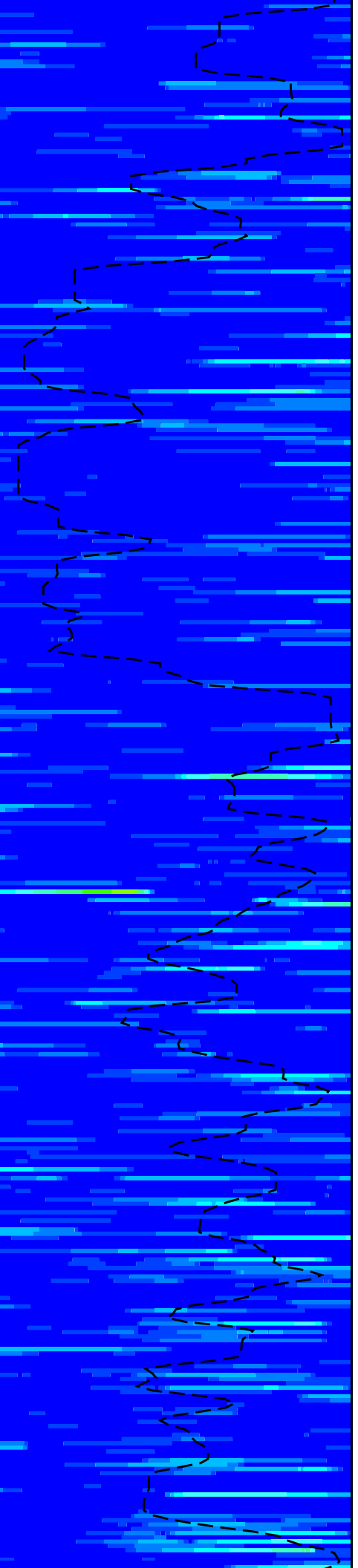
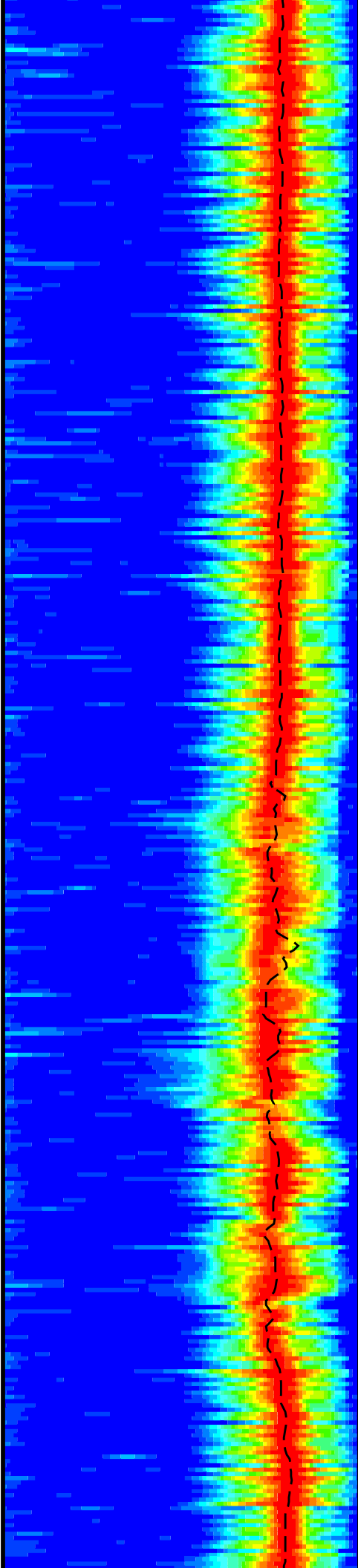

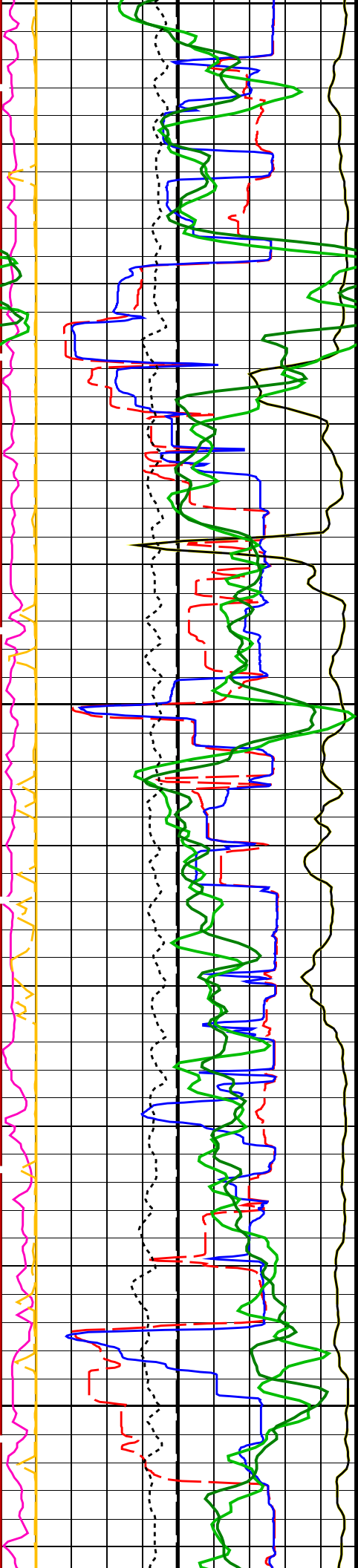

300

325

350

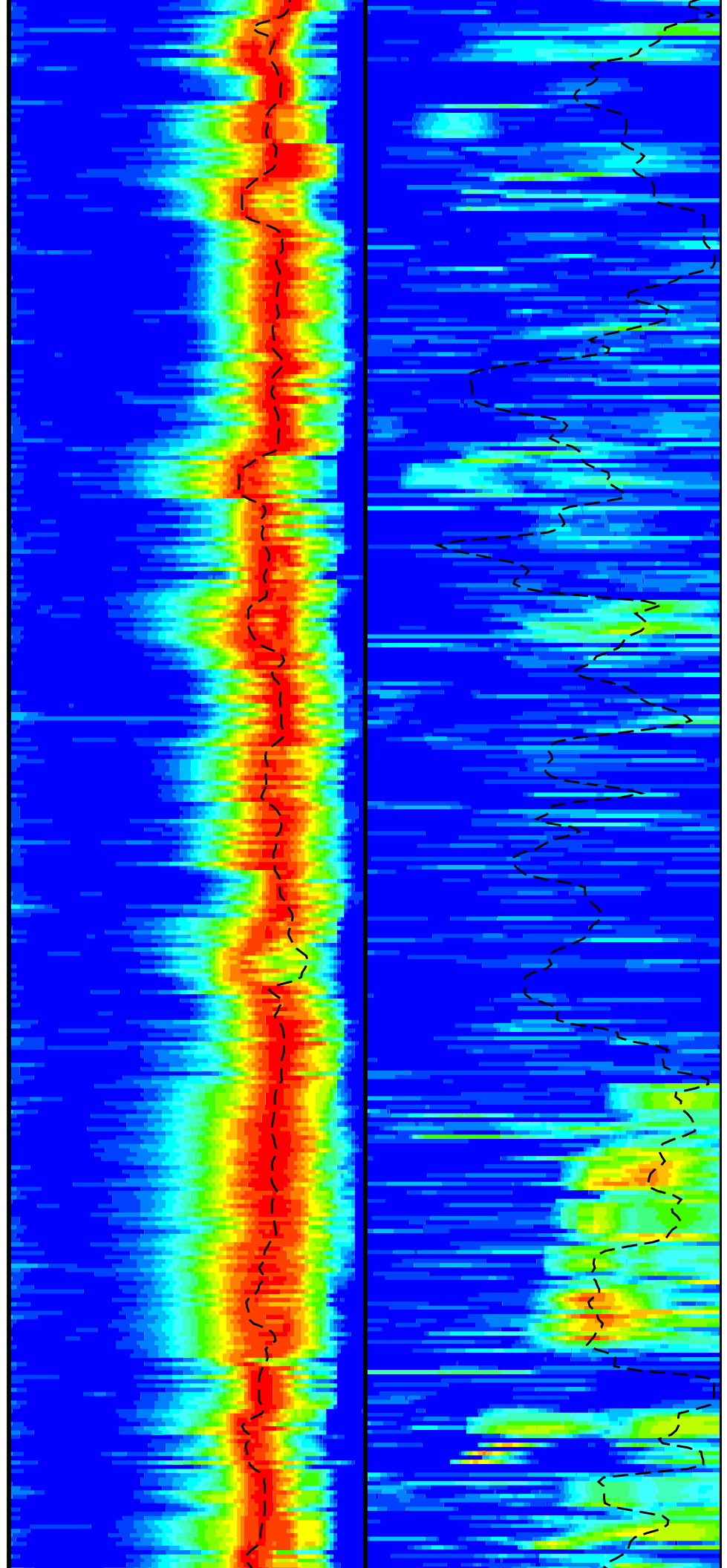

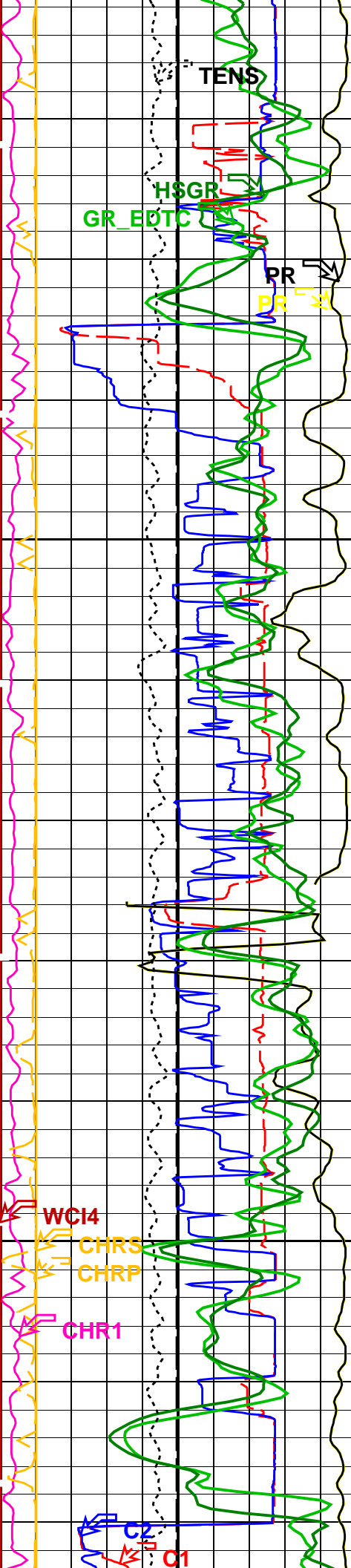

375

400

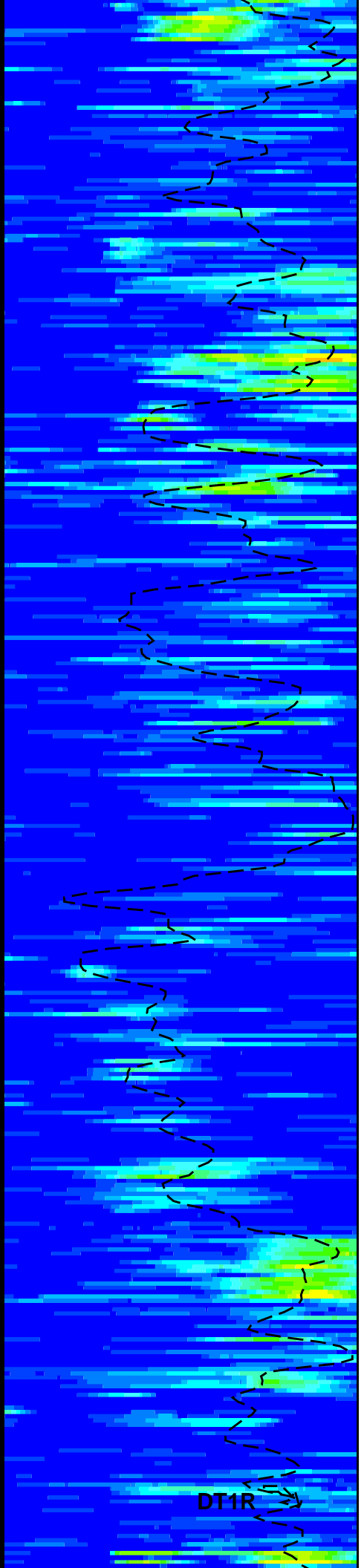
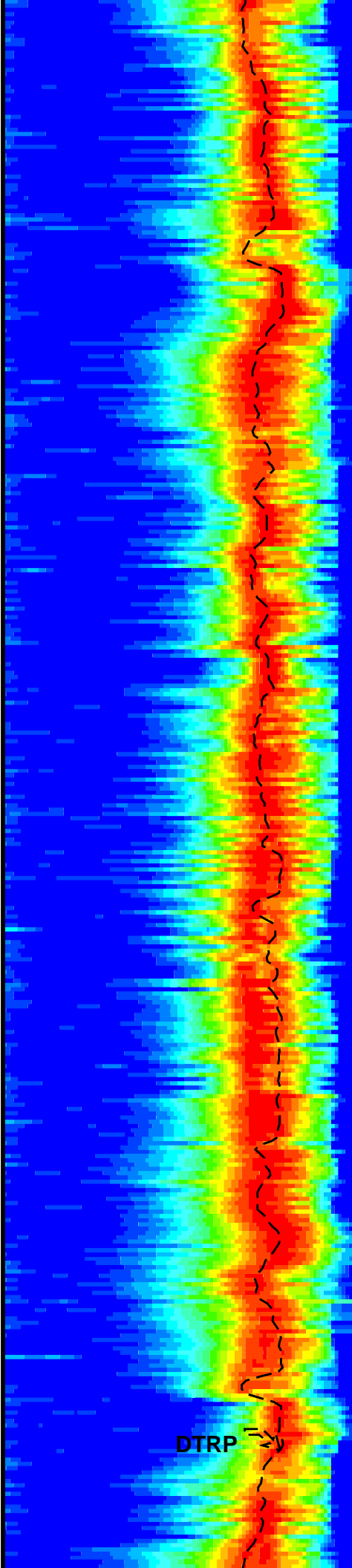

DTRP

DT1R

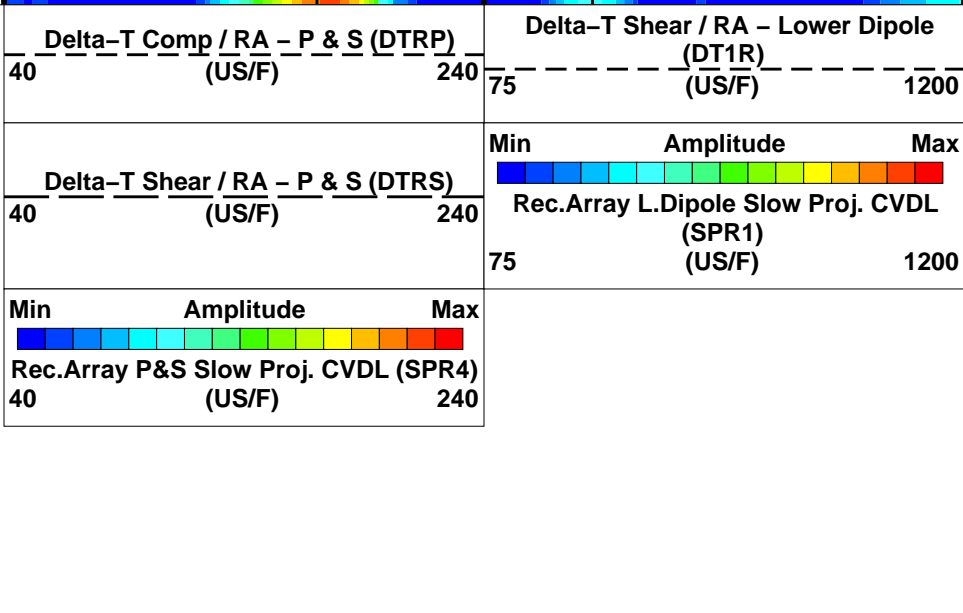
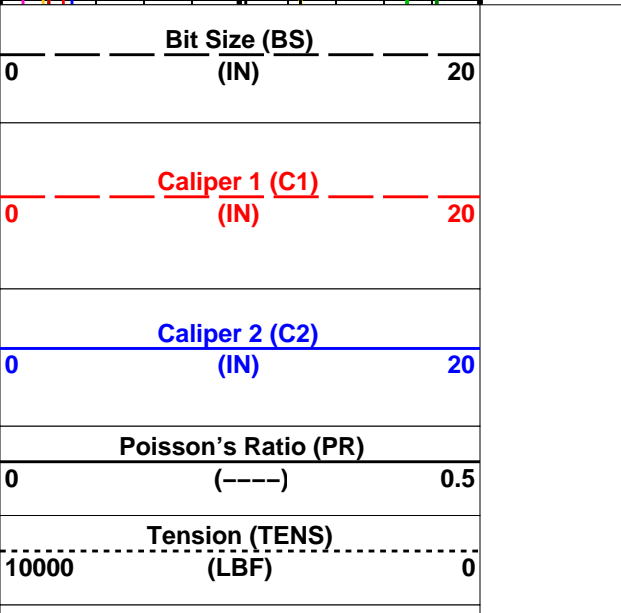
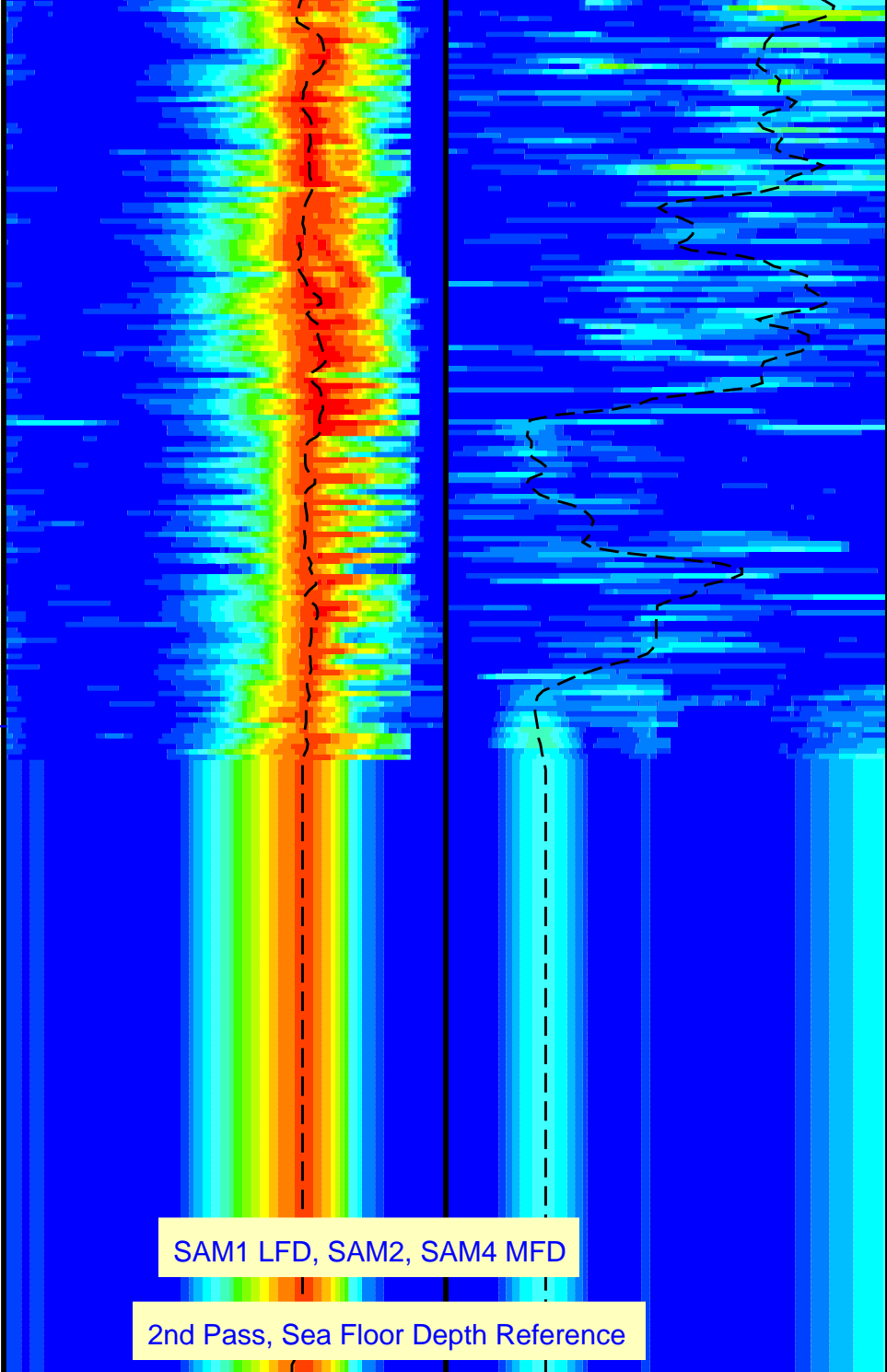
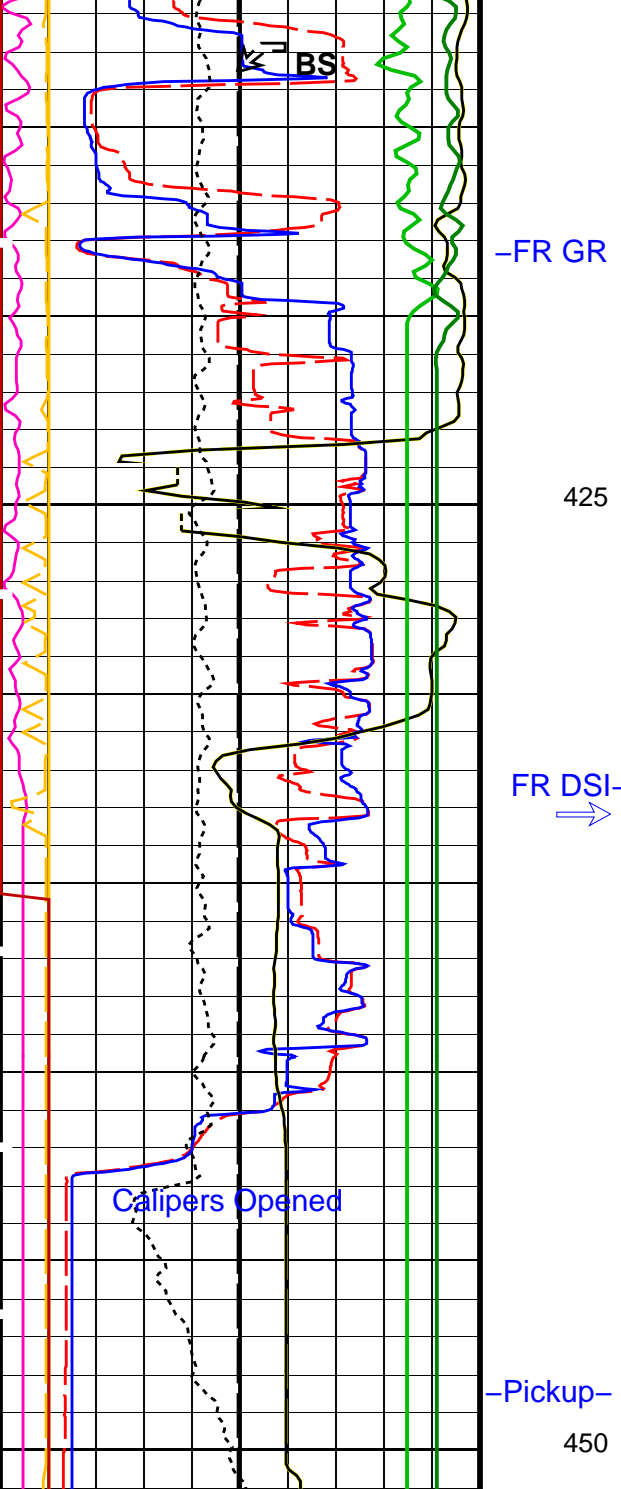

0	Poisson's Ratio (PR) (-----)	0.5
<b>Gamma Ray (GR_EDTC)</b>		
0	(GAPI)	100
<b>Peak Coherence / RA – Lower Dipole (CHR1)</b>		
0	(-----)	10
<b>Peak Coherence / RA – P &amp; S Comp (CHRP)</b>		
0	(-----)	10
<b>Peak Coherence / RA – P &amp; S Shear (CHRS)</b>		
-1	(-----)	9
<b>Waveform Data Copy Indicator 4 – Monopole P&amp;S (WCI4)</b>		
0	(-----)	10
<b>HNGS Spectroscopy Gamma Ray (HSGR)</b>		
0	(GAPI)	100

PIP SUMMARY

Time Mark Every 60 S

Parameters

DLIS Name	Description	Value
DSST-B: Dipole Shear Imager – B		
BHS	Borehole Status	OPEN
CASF	Label Casing Function – Monopole P&S	50
COLL	Label Slowness Lower Limit – Monopole P&S Compressional	60 US/F
COUL	Label Slowness Upper Limit – Monopole P&S Compressional	209 US/F
DDE1	Digitizing Delay 1	0 US
DDE4	Digitizing Delay 4	0 US
DDEX	Digitizing Delay X	0 US
DLCS	Label Compressional Source – Dipole Shear	USE
DSHL	Label Slowness Lower Limit – Dipole Shear	75 US/F
DSHU	Label Slowness Upper Limit – Dipole Shear	1200 US/F
DSI1	Digitizer Sample Interval 1	40 US
DSI4	Digitizer Sample Interval 4	10 US
DSIX	Digitizer Sample Interval X	40 US
DTCS	Compressional Delta-T Source for DTCS Channel	PS_COMP
DTF	Delta-T Fluid	210 US/F
DTSS	Shear Delta-T Source for DTSM Channel	LOWER_DIPOLE
DWC1	Digitizer Word Count 1	512
DWC4	Digitizer Word Count 4	512
DWCX	Digitizer Word Count X	512
FILG	Label Fill Gap Control – Monopole P&S	COMP
GCSE	Generalized Caliper Selection	BS
LFC	Label Formation Character – Monopole P&S	COMP_FIRST
LTXG	Lower Dipole Transmitter Geometry	156 IN
MCS	Mean Casing Slowness	57 US/F
MTXG	Monopole Transmitter Geometry	186 IN
NWI1	Number Waveform Items 1	8
NWI4	Number Waveform Items 4	8
NWIX	Number Waveform Items X	0
RSMN	Label Shear/Compressional Minimum Ratio – Monopole P&S	1.4
RSMX	Label Shear/Compressional Maximum Ratio – Monopole P&S	2.12
RX1G	Receiver 1 Geometry	294 IN
RX2G	Receiver 2 Geometry	300 IN
RX3G	Receiver 3 Geometry	306 IN
RX4G	Receiver 4 Geometry	312 IN
RX5G	Receiver 5 Geometry	318 IN
RX6G	Receiver 6 Geometry	324 IN
RX7G	Receiver 7 Geometry	330 IN
RX8G	Receiver 8 Geometry	336 IN
SAM1	DSST Sonic Acquisition Mode 1 – Lower Dipole Mode	LFD_EVEN
SAM4	DSST Sonic Acquisition Mode 4 – Monopole Mode for P&S	MFD_EVEN
SAMX	DSST Sonic Acquisition Mode X – Both Dipoles or Monopole Mode for Expert	OFF
SAS1	STC Sonic Array Status – Lower Dipole	255
SAS4	STC Sonic Array Status – Monopole P&S	255
SBO1	STC Search Band Offset – Lower Dipole	3000 US

SBO4	STC Search Band Offset - Monopole P&S	500	US
SBR4	STC Baseline Removal - Monopole P&S	ON	
SBW1	STC Search Bandwidth - Lower Dipole	8000	US
SBW4	STC Search Bandwidth - Monopole P&S	2000	US
SFC1	STC Formation Character - Lower Dipole	SELECTABLE	
SFC4	STC Formation Character - Monopole P&S	SELECTABLE	
SFM1	STC Filter - Lower Dipole	B.3-1.5K	
SFM4	STC Filter - Monopole P&S	B3-12K	
SHLL	Label Slowness Lower Limit - Monopole P&S Shear	235	US/F
SHUL	Label Slowness Upper Limit - Monopole P&S Shear	240	US/F
SLL1	STC Slowness Lower Limit - Lower Dipole	75	US/F
SLL4	STC Slowness Lower Limit - Monopole P&S	40	US/F
SST1	STC Slowness Step - Lower Dipole	4	US/F
SST4	STC Slowness Step - Monopole P&S	2	US/F
SSW1	STC Source Waveform - Lower Dipole	WF_SAM1	
SSW4	STC Source Waveform - Monopole P&S	WF_SAM4	
STLL	Label Slowness Lower Limit - Monopole Stoneley	180	US/F
STUL	Label Slowness Upper Limit - Monopole Stoneley	1200	US/F
SUL1	STC Slowness Upper Limit - Lower Dipole	1200	US/F
SUL4	STC Slowness Upper Limit - Monopole P&S	240	US/F
SWD1	STC Slowness Width - Lower Dipole	40	US/F
SWD4	STC Slowness Width - Monopole P&S	10	US/F
TBF1	STC Time for Baseline Fill - Lower Dipole	0	US
TBF4	STC Time for Baseline Fill - Monopole P&S	300	US
TLL1	STC Time Lower Limit - Lower Dipole	600	US
TLL4	STC Time Lower Limit - Monopole P&S	150	US
TST1	STC Time Step - Lower Dipole	200	US
TST4	STC Time Step - Monopole P&S	50	US
TUL1	STC Time Upper Limit - Lower Dipole	20440	US
TUL4	STC Time Upper Limit - Monopole P&S	3660	US
TWD1	STC Time Width - Lower Dipole	2000	US
TWD4	STC Time Width - Monopole P&S	1000	US
TWI1	STC Integration Time Window - Lower Dipole	1600	US
TWI4	STC Integration Time Window - Monopole P&S	500	US
TWSX	Transmitter Waveform Select X	0	
WFM4	Waveform Mode 4	W1	
<b>HNGS-BA: Hostile Natural Gamma Ray Sonde</b>			
BAR1	HNGS Detector 1 Barite Constant	1	
BAR2	HNGS Detector 2 Barite Constant	1	
BHK	HNGS Borehole Potassium Correction Concentration	0	
BHS	Borehole Status	OPEN	
CSD1	Inner Casing Outer Diameter	0	IN
CSD2	Outer Casing Outer Diameter	0	IN
CSW1	Inner Casing Weight	0	LB/F
CSW2	Outer Casing Weight	0	LB/F
DBCC	HNGS Barite Constant Correction Flag	NONE	
GCSE	Generalized Caliper Selection	BS	
H1P	HNGS Detector 1 Allow/Disallow In Processing	ALLOW	
H2P	HNGS Detector 2 Allow/Disallow In Processing	ALLOW	
HABK	HNGS Borehole Potassium Running Average	-0.0012706	
HALF	HNGS Alpha Filter Length	60	IN
HCRB	HNGS Apply Borehole Potassium Correction	NONE	
HMWM	Mud Weighting Material	NATU	
HNPE	HNGS Processing Enable	YES	
S1BI	HNGS Detector 1 Calibration Bismuth Count Rate	1.3	CPS
S2BI	HNGS Detector 2 Calibration Bismuth Count Rate	1.3	CPS
SGRC	HNGS Standard Gamma-Ray Correction Flag	YES	
TPOS	Tool Position	CENT	
VBA1	HNGS Detector 1 Variable Barite Factor Running Average	0.991683	
VBA2	HNGS Detector 2 Variable Barite Factor Running Average	0.994182	
<b>EDTC-B: Enhanced DTS Cartridge</b>			
BHS	Borehole Status	OPEN	
GCSE	Generalized Caliper Selection	BS	
<b>System and Miscellaneous</b>			
BS	Bit Size	9.875	IN
DFD	Drilling Fluid Density	1.03	G/C3
DO	Depth Offset for Playback	-4251.0	M
PP	Playback Processing	NORMAL	

Format: DSST\_P\_S\_LOWER\_VDL\_COLOR Vertical Scale: 1:200 Graphics File Created: 17-Mar-2014 14:43

## OP System Version: 19C0-187

MEST-B	19C0-187	DTA-A	8453
DSST-B	19C0-187	HNGC-B	19C0-187
HNGS-BA	19C0-187	EDTC-B	SKK-5169-EDTCB

## Input DLIS Files

DEFAULT	FMS_DSI_NGS_037PUP	FN:59	PRODUCER	18-Feb-2014 04:12	4702.3 M	4242.8 M
---------	--------------------	-------	----------	-------------------	----------	----------



# Output DLIS Files

DEFAULT

FMS\_DSI\_NGS\_061PUP

FN:81

PRODUCER

17-Mar-2014 14:43

Company: Lamont Doherty Earth Observatory

Well: Expedition 349, Site U1431

## Input DLIS Files

DEFAULT

FMS\_DSI\_NGS\_037PUP

FN:59

PRODUCER

18-Feb-2014 04:12

4702.3 M

4242.8 M

## Output DLIS Files

DEFAULT

FMS\_DSI\_NGS\_061PUP

FN:81

PRODUCER

17-Mar-2014 14:43

451.1 M

-8.2 M

## OP System Version: 19C0-187

MEST-B 19C0-187  
 DSST-B 19C0-187  
 HNGS-BA 19C0-187

DTA-A 8453  
 HNGC-B 19C0-187  
 EDTC-B SKK-5169-EDTCB

### PIP SUMMARY

Time Mark Every 60 S

**HNGS Spectroscopy Gamma Ray (HSGR)**  
 0 (GAPI) 100

**Waveform Data Copy Indicator 4 - Monopole P&S (WCI4)**  
 0 (----) 10

**Peak Coherence / RA - P & S Shear (CHRS)**  
 -1 (----) 9

**Peak Coherence / RA - P & S Comp (CHRP)**  
 0 (----) 10

**Peak Coherence / RA - Upper Dipole (CHR2)**  
 0 (----) 10

**Gamma Ray (GR\_EDTC)**  
 0 (GAPI) 100

**Poisson's Ratio (PR)**  
 0 (----) 0.5

**Poisson's Ratio (PR)**  
 0 (----) 0.5

**Caliper 1 (C1)**  
 0 (IN) 20

**Caliper 2 (C2)**  
 0 (IN) 20

**Bit Size (BS)**  
 0 (IN) 20

SAM1 LFD, SAM2, SAM4 MFD

2nd Pass, Sea Floor Depth Reference

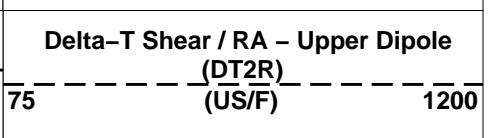
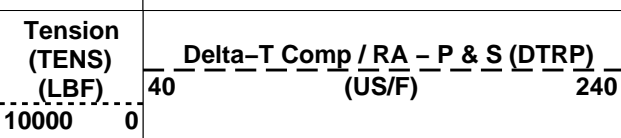
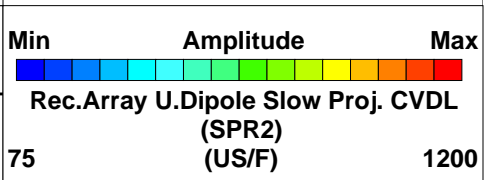
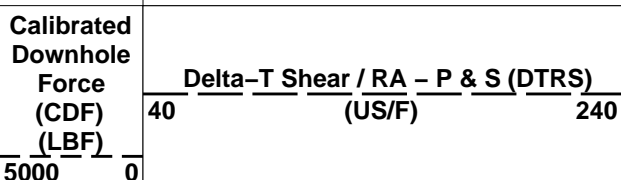
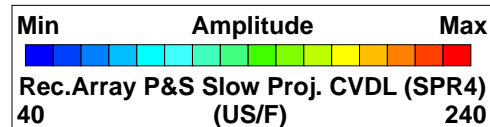

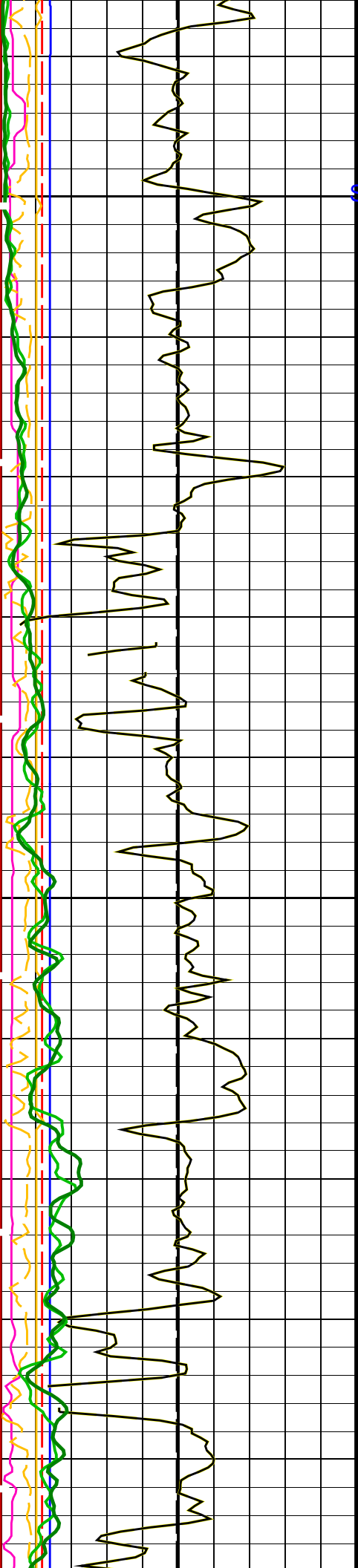

Sea Floor



25

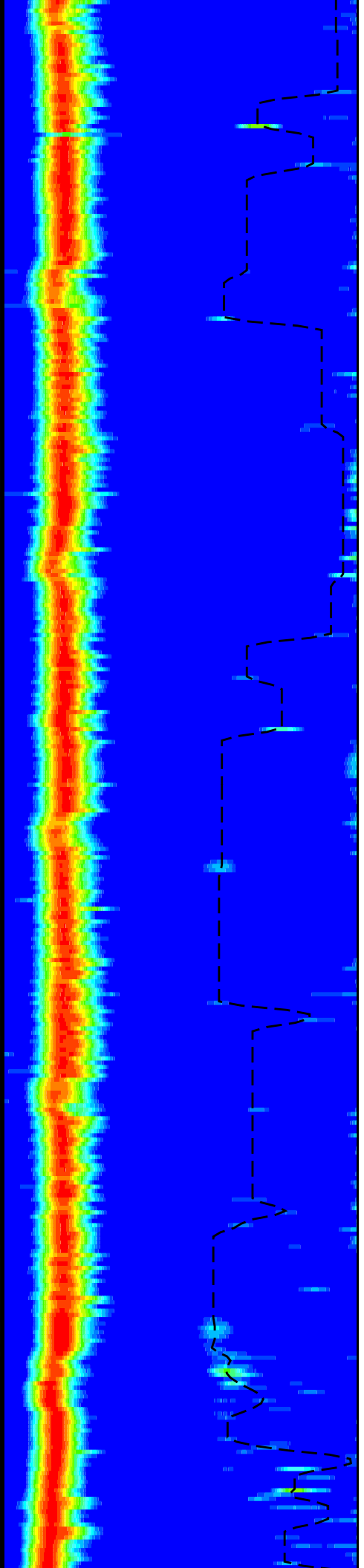
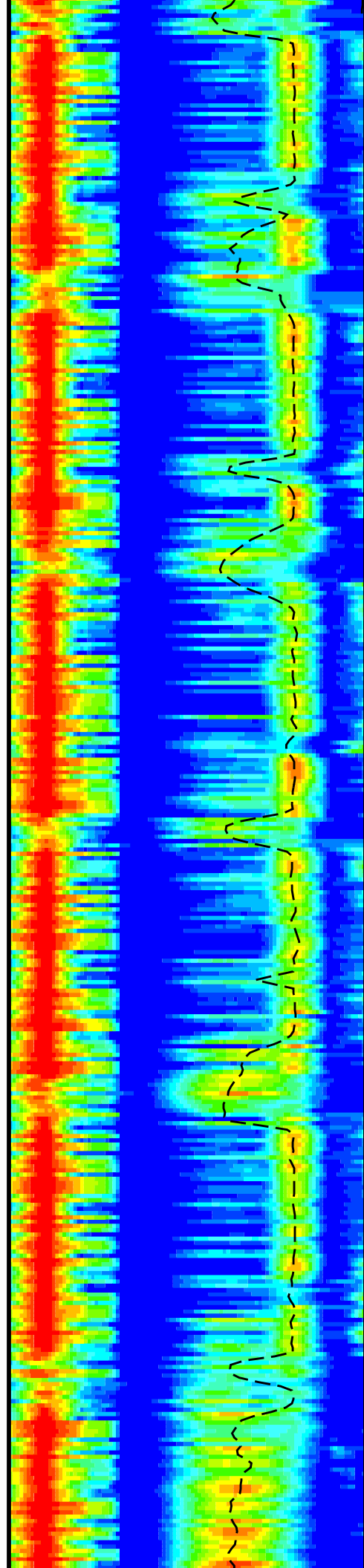

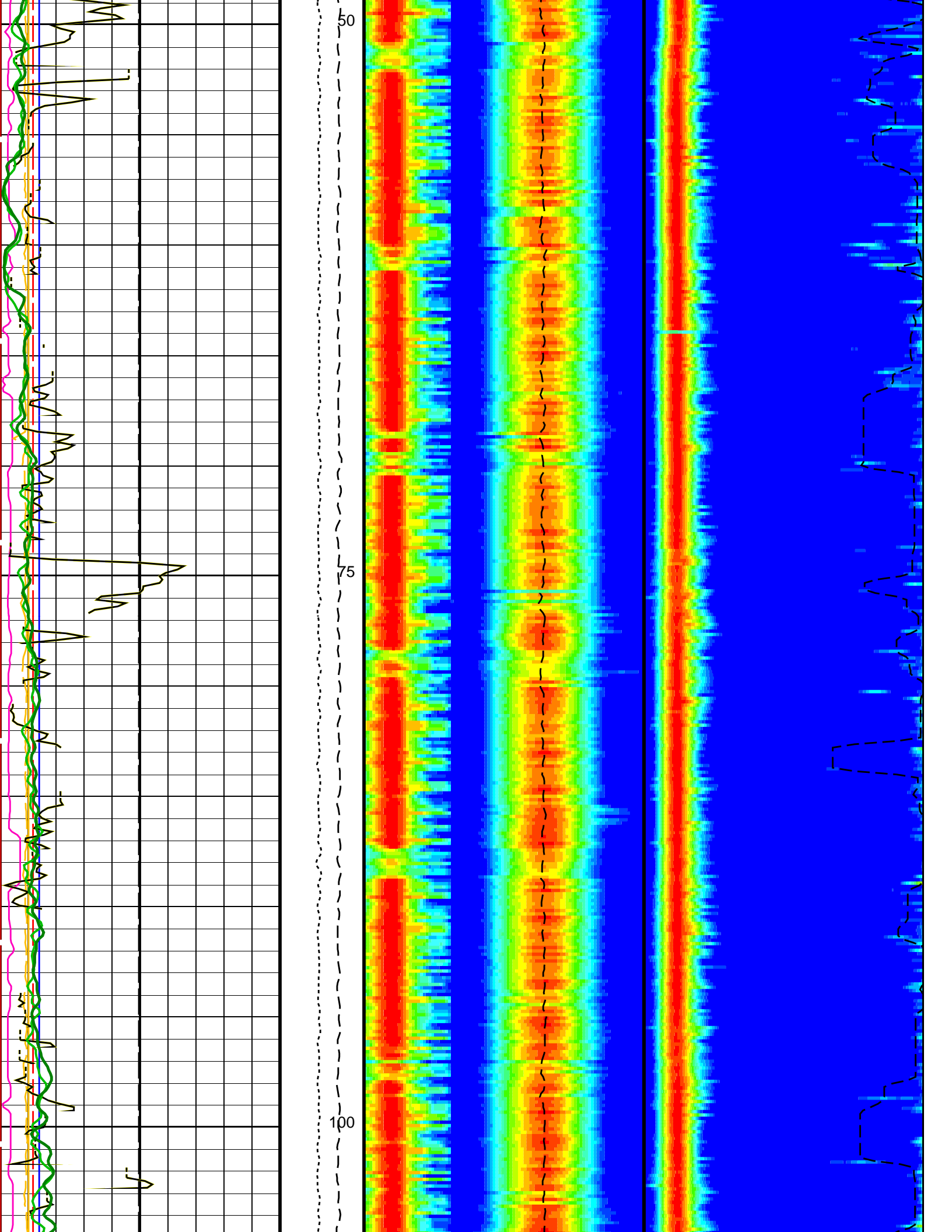

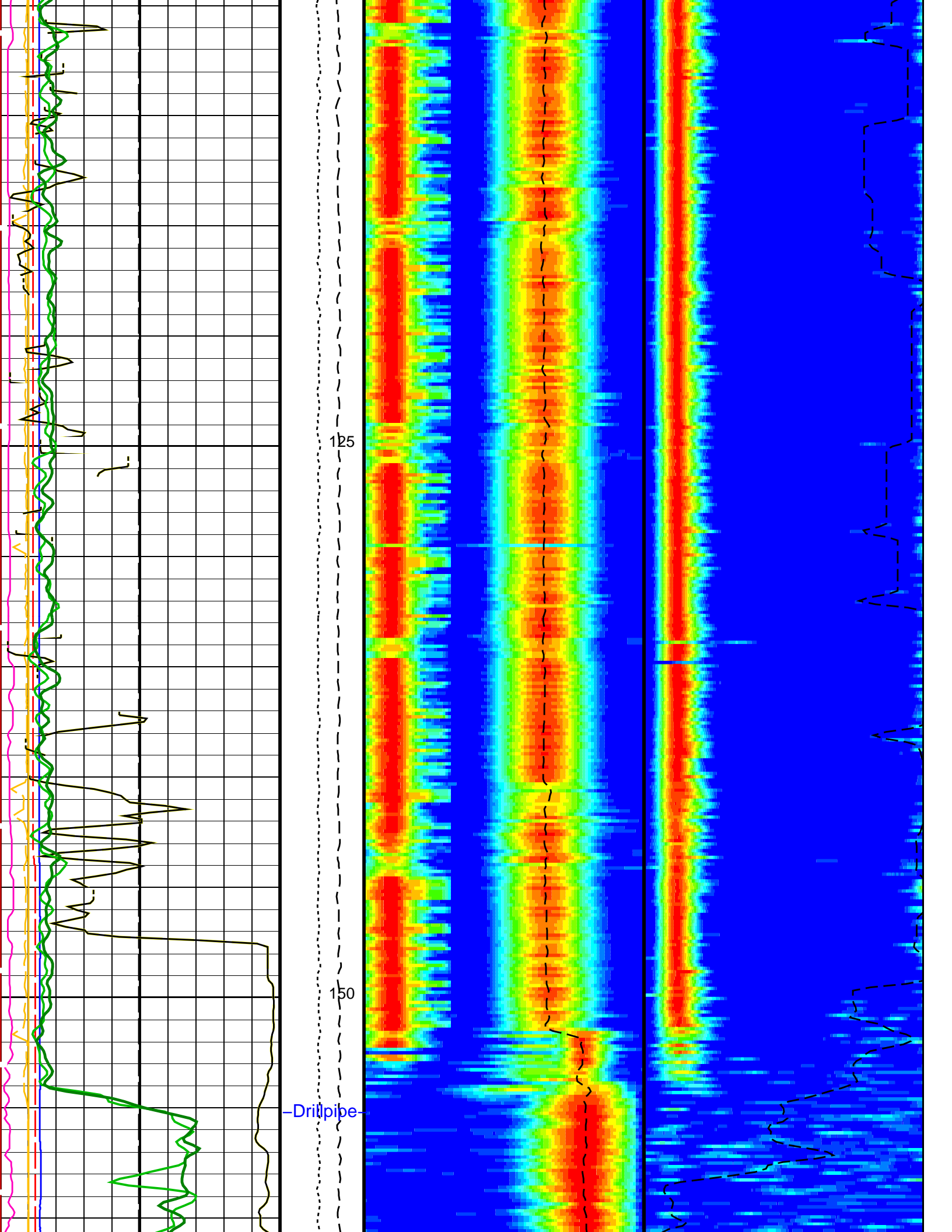

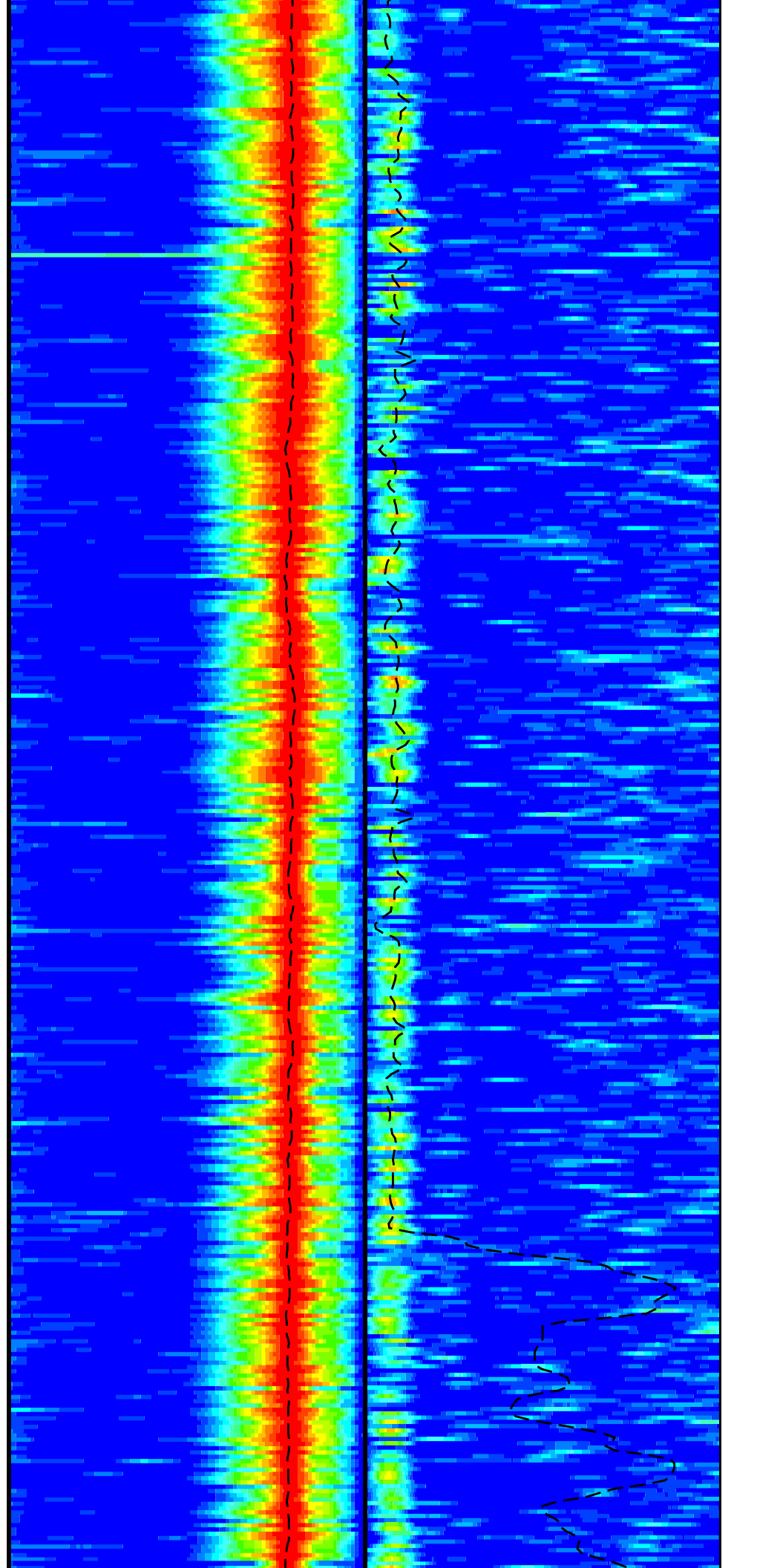
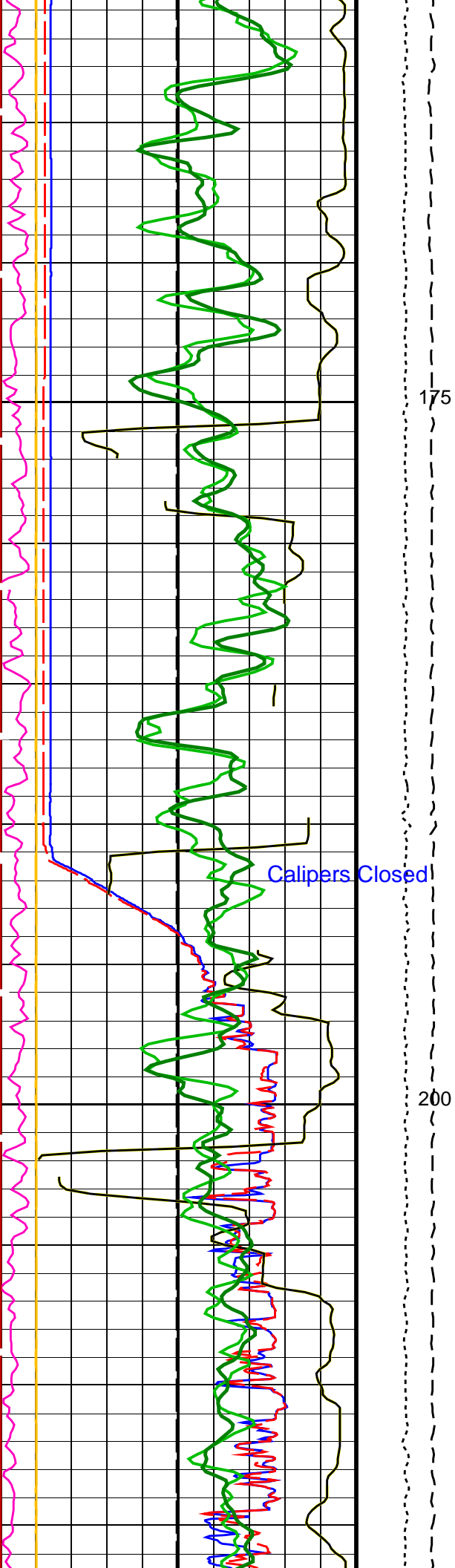

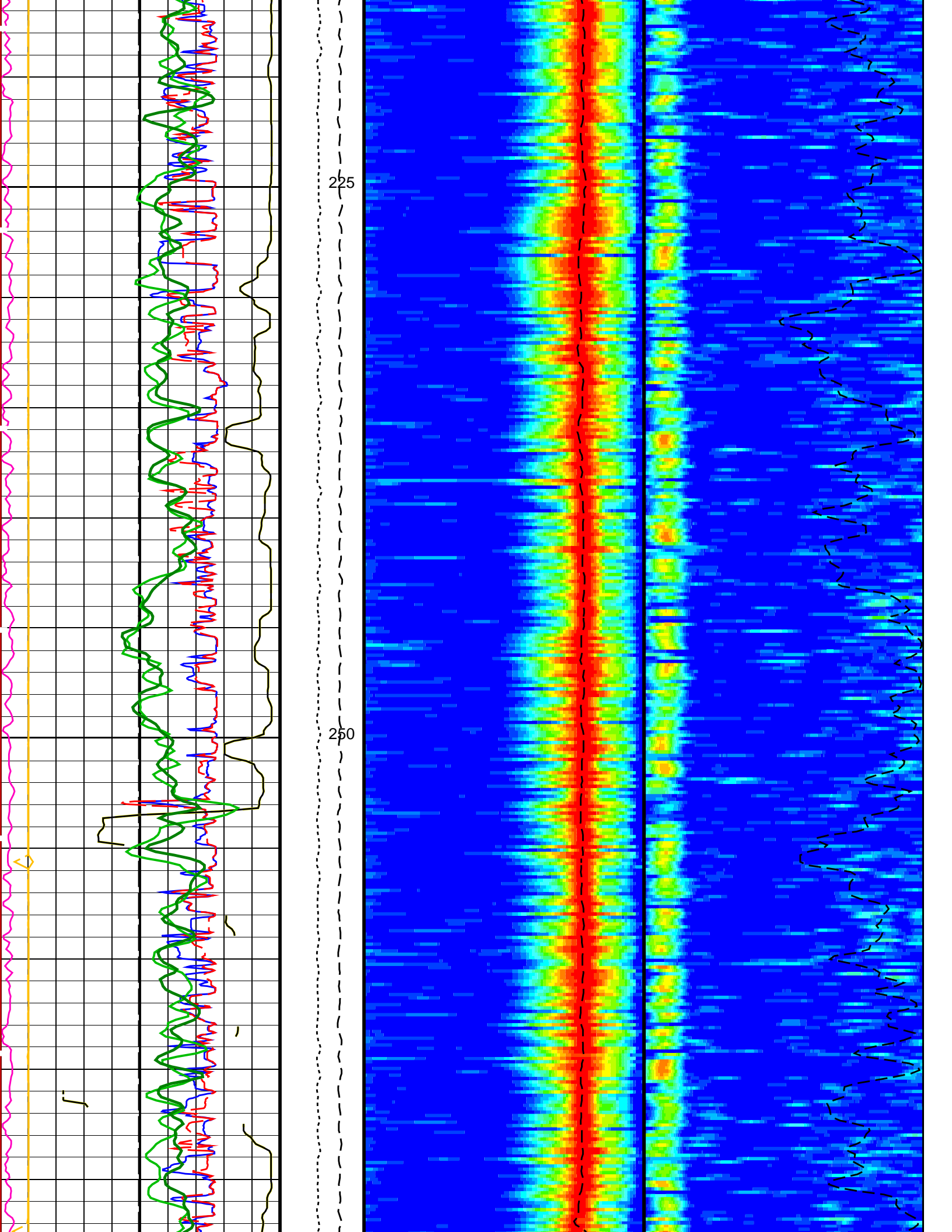

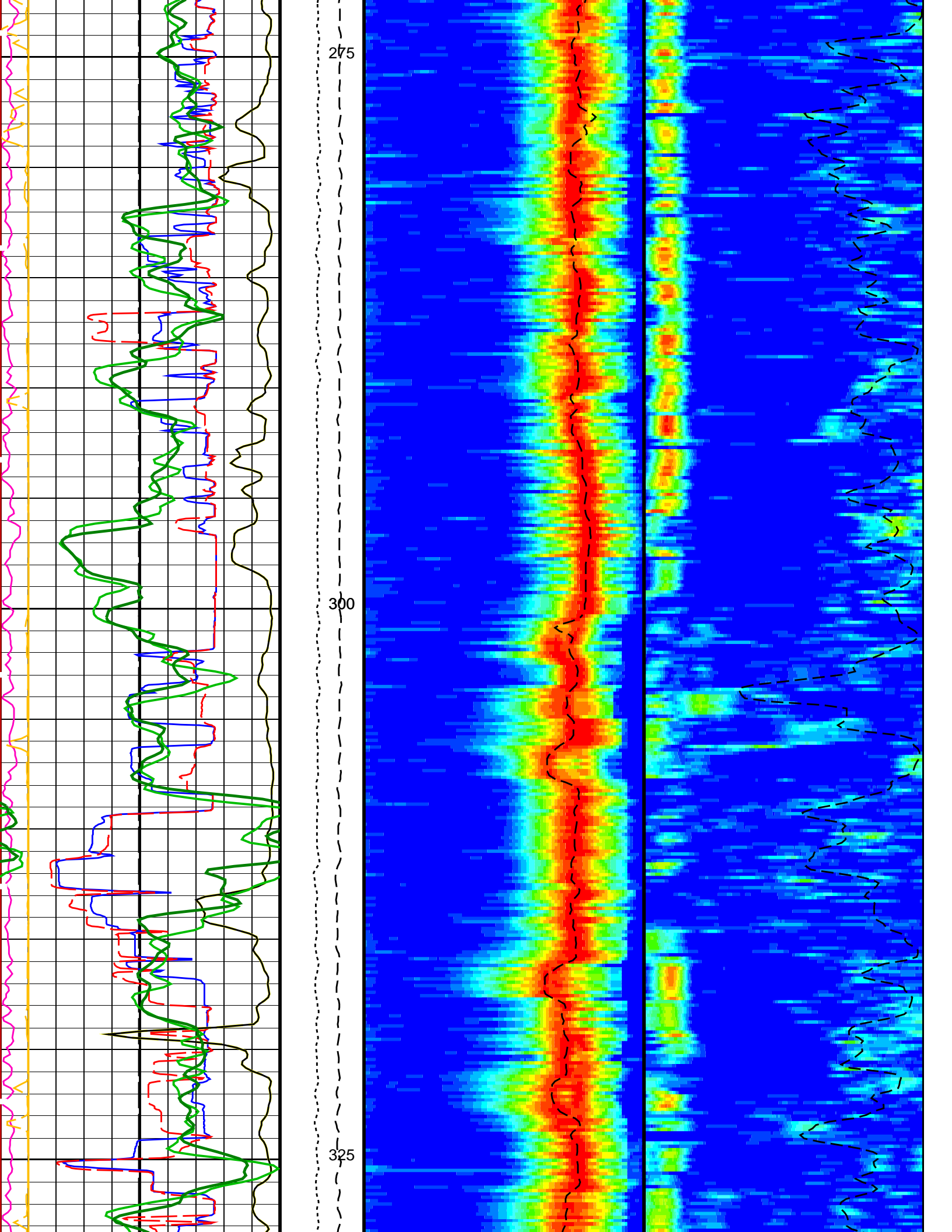

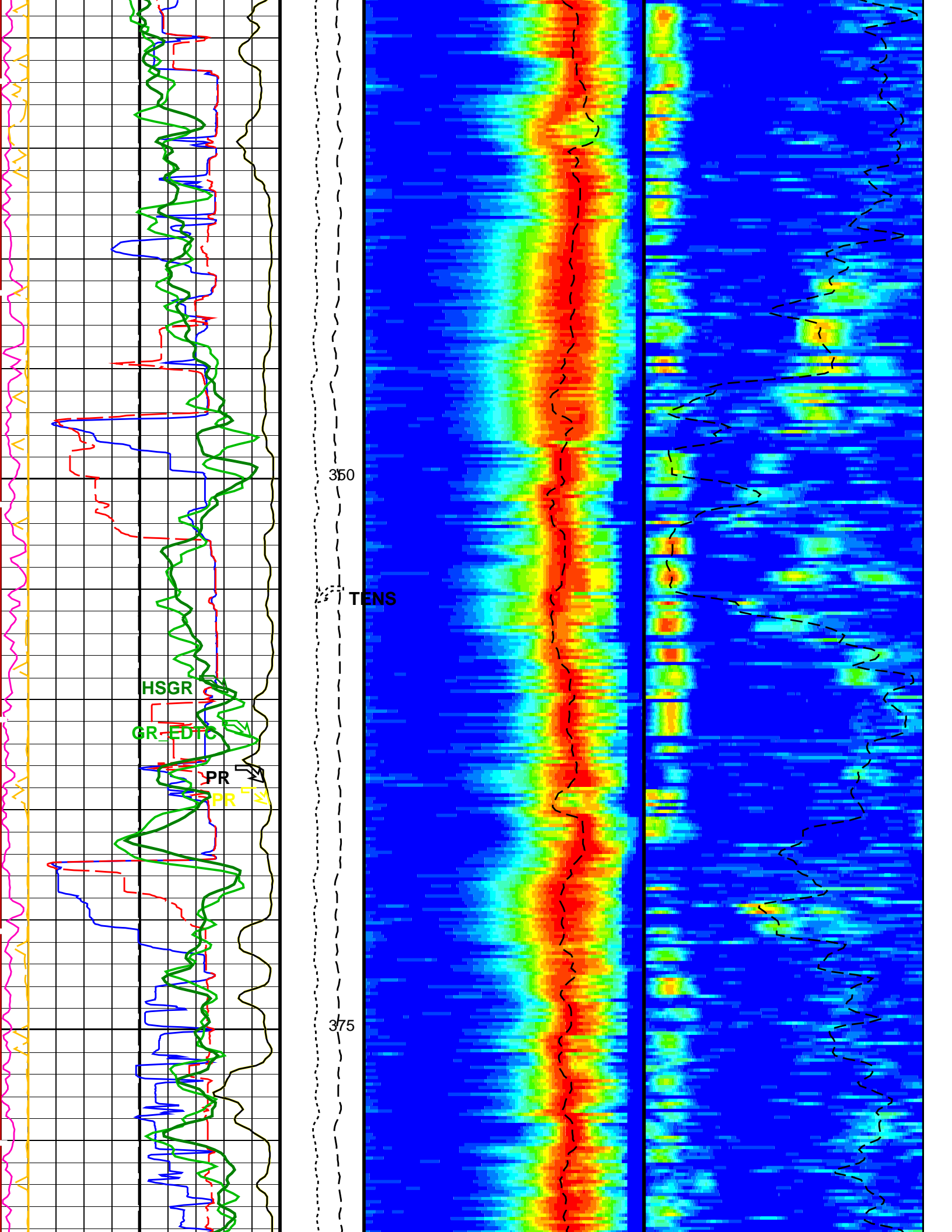



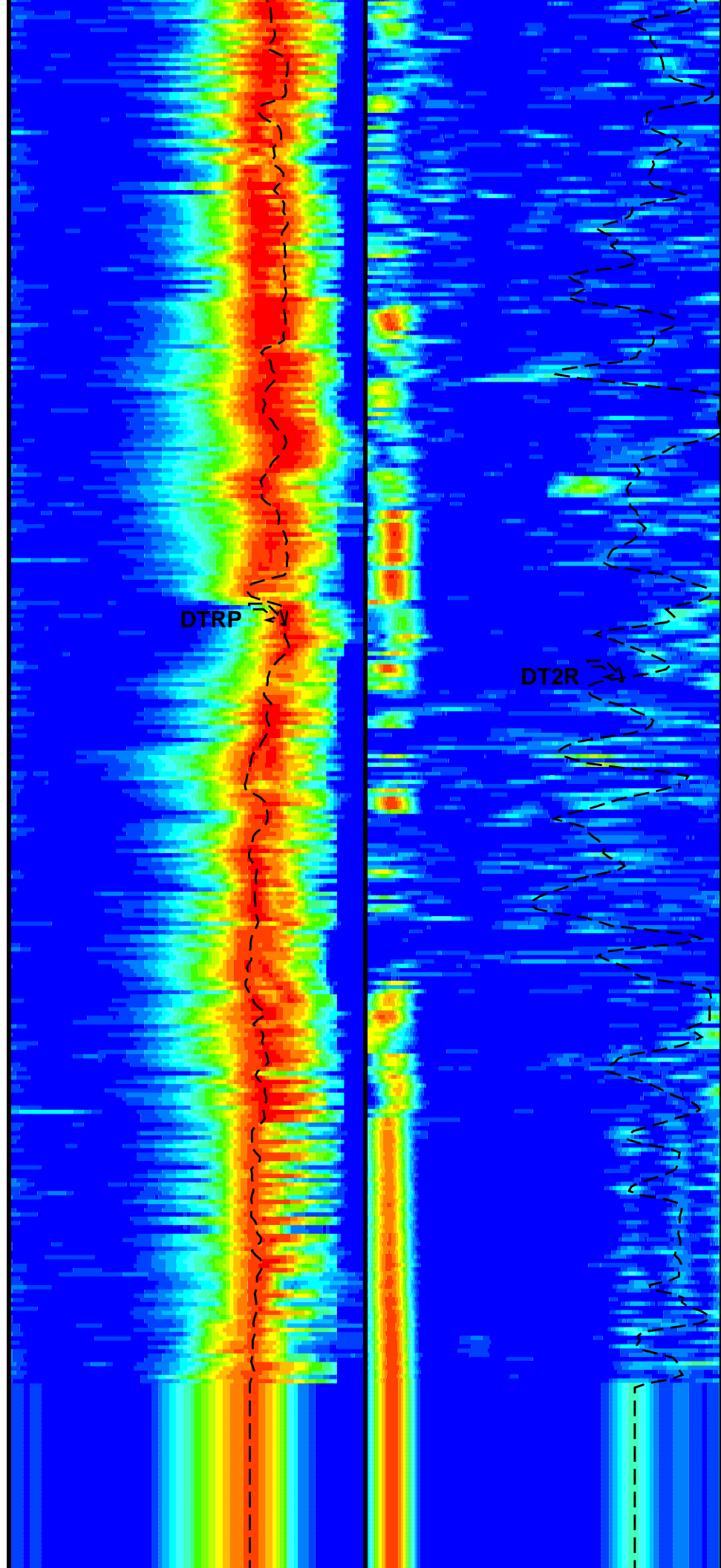
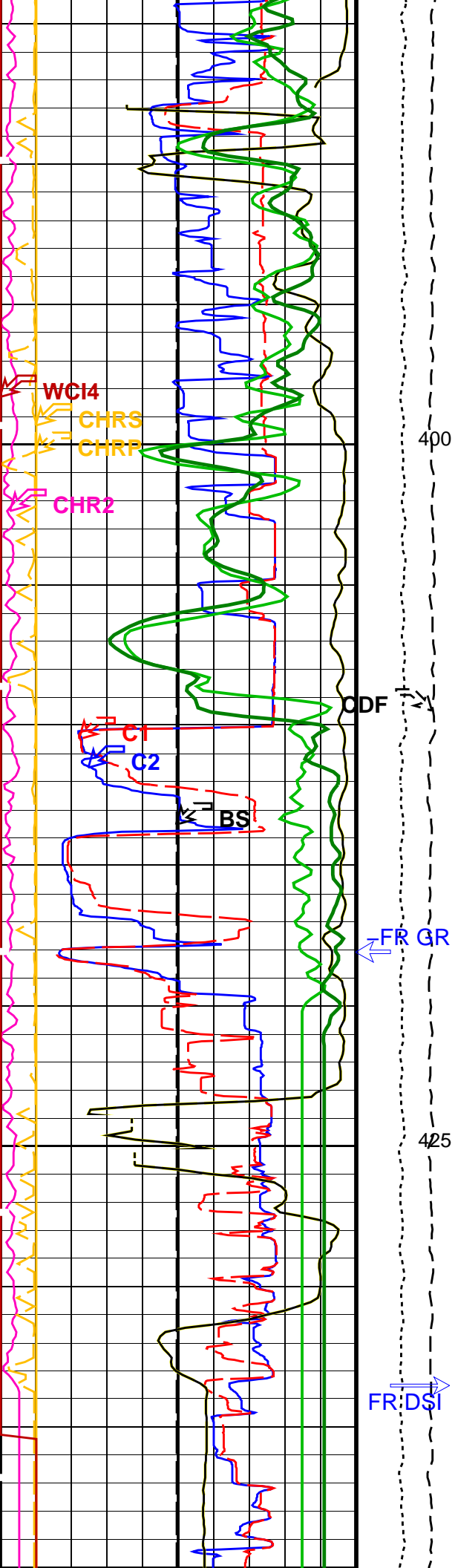

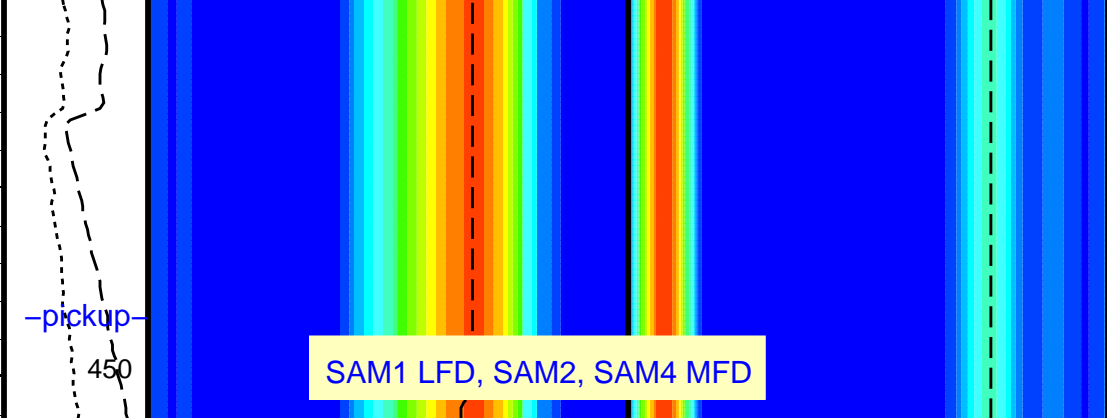
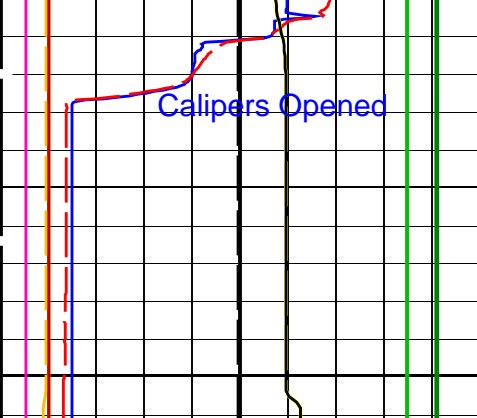

Bit Size (BS) (IN)	0	20
Caliper 2 (C2) (IN)	0	20
Caliper 1 (C1) (IN)	0	20
Poisson's Ratio (PR) (----)	0	0.5
Poisson's Ratio (PR) (----)	0	0.5
Gamma Ray (GR_EDTC) (GAPI)	0	100
Peak Coherence / RA - Upper Dipole (CHR2)	0	10
Peak Coherence / RA - P & S Comp (CHRP)	0	10
Peak Coherence / RA - P & S Shear (CHRS)	-1	9
Waveform Data Copy Indicator 4 - Monopole P&S (WCI4)	0	10
HNGS Spectroscopy Gamma Ray (HSGR) (GAPI)	0	100

Tension (TENS) (LBF)	10000	0
Delta-T Comp / RA - P & S (DTRP) (US/F)	40	240
Delta-T Shear / RA - P & S (DTRS) (US/F)	40	240
Min	40	240
Max	240	240

Delta-T Shear / RA - Upper Dipole (DT2R) (US/F)	75	1200
Min	75	1200
Max	1200	1200

2nd Pass, Sea Floor Depth Reference

PIP SUMMARY

Time Mark Every 60 S

Parameters

DLIS Name	Description	Value
DSST-B:	Dipole Shear Imager - B	
BHS	Borehole Status	OPEN
CASF	Label Casing Function - Monopole P&S	50
COLL	Label Slowness Lower Limit - Monopole P&S Compressional	60 US/F
COUL	Label Slowness Upper Limit - Monopole P&S Compressional	209 US/F
DDE2	Digitizing Delay 2	0 US

DDE4	Digitizing Delay 2	0	US
DDEX	Digitizing Delay X	0	US
DLCS	Label Compressional Source – Dipole Shear	USE	
DSHL	Label Slowness Lower Limit – Dipole Shear	75	US/F
DSHU	Label Slowness Upper Limit – Dipole Shear	1200	US/F
DSI2	Digitizer Sample Interval 2	40	US
DSI4	Digitizer Sample Interval 4	10	US
DSIX	Digitizer Sample Interval X	40	US
DTCS	Compressional Delta-T Source for DTCS Channel	PS_COMP	
DTF	Delta-T Fluid	210	US/F
DTSS	Shear Delta-T Source for DTSM Channel	LOWER_DIPOLE	
DWC2	Digitizer Word Count 2	512	
DWC4	Digitizer Word Count 4	512	
DWCX	Digitizer Word Count X	512	
FILG	Label Fill Gap Control – Monopole P&S	COMP	
GCSE	Generalized Caliper Selection	BS	
LFC	Label Formation Character – Monopole P&S	COMP_FIRST	
MCS	Mean Casing Slowness	57	US/F
MTXG	Monopole Transmitter Geometry	186	IN
NWI2	Number Waveform Items 2	8	
NWI4	Number Waveform Items 4	8	
NWIX	Number Waveform Items X	0	
RSMN	Label Shear/Compressional Minimum Ratio – Monopole P&S	1.4	
RSMX	Label Shear/Compressional Maximum Ratio – Monopole P&S	2.12	
RX1G	Receiver 1 Geometry	294	IN
RX2G	Receiver 2 Geometry	300	IN
RX3G	Receiver 3 Geometry	306	IN
RX4G	Receiver 4 Geometry	312	IN
RX5G	Receiver 5 Geometry	318	IN
RX6G	Receiver 6 Geometry	324	IN
RX7G	Receiver 7 Geometry	330	IN
RX8G	Receiver 8 Geometry	336	IN
SAM2	DSST Sonic Acquisition Mode 2 – Upper Dipole Mode	ODD	
SAM4	DSST Sonic Acquisition Mode 4 – Monopole Mode for P&S	MFD_EVEN	
SAMX	DSST Sonic Acquisition Mode X – Both Dipoles or Monopole Mode for Expert	OFF	
SAS2	STC Sonic Array Status – Upper Dipole	255	
SAS4	STC Sonic Array Status – Monopole P&S	255	
SBO2	STC Search Band Offset – Upper Dipole	3000	US
SBO4	STC Search Band Offset – Monopole P&S	500	US
SBR4	STC Baseline Removal – Monopole P&S	ON	
SBW2	STC Search Bandwidth – Upper Dipole	8000	US
SBW4	STC Search Bandwidth – Monopole P&S	2000	US
SFC2	STC Formation Character – Upper Dipole	SELECTABLE	
SFC4	STC Formation Character – Monopole P&S	SELECTABLE	
SFM2	STC Filter – Upper Dipole	B1-2K	
SFM4	STC Filter – Monopole P&S	B3-12K	
SHLL	Label Slowness Lower Limit – Monopole P&S Shear	235	US/F
SHUL	Label Slowness Upper Limit – Monopole P&S Shear	240	US/F
SLL2	STC Slowness Lower Limit – Upper Dipole	75	US/F
SLL4	STC Slowness Lower Limit – Monopole P&S	40	US/F
SST2	STC Slowness Step – Upper Dipole	4	US/F
SST4	STC Slowness Step – Monopole P&S	2	US/F
SSW2	STC Source Waveform – Upper Dipole	WF_SAM2	
SSW4	STC Source Waveform – Monopole P&S	WF_SAM4	
STLL	Label Slowness Lower Limit – Monopole Stoneley	180	US/F
STUL	Label Slowness Upper Limit – Monopole Stoneley	1200	US/F
SUL2	STC Slowness Upper Limit – Upper Dipole	1200	US/F
SUL4	STC Slowness Upper Limit – Monopole P&S	240	US/F
SWD2	STC Slowness Width – Upper Dipole	40	US/F
SWD4	STC Slowness Width – Monopole P&S	10	US/F
TBF2	STC Time for Baseline Fill – Upper Dipole	0	US
TBF4	STC Time for Baseline Fill – Monopole P&S	300	US
TLL2	STC Time Lower Limit – Upper Dipole	600	US
TLL4	STC Time Lower Limit – Monopole P&S	150	US
TST2	STC Time Step – Upper Dipole	200	US
TST4	STC Time Step – Monopole P&S	50	US
TUL2	STC Time Upper Limit – Upper Dipole	20200	US
TUL4	STC Time Upper Limit – Monopole P&S	3660	US
TWD2	STC Time Width – Upper Dipole	2000	US
TWD4	STC Time Width – Monopole P&S	1000	US
TWI2	STC Integration Time Window – Upper Dipole	1600	US
TWI4	STC Integration Time Window – Monopole P&S	500	US
TWSX	Transmitter Waveform Select X	0	
UTXG	Upper Dipole Transmitter Geometry	162	IN
WFM4	Waveform Mode 4	W1	
HNGS-BA: Hostile Natural Gamma Ray Sonde			
BAR1	HNGS Detector 1 Barite Constant	1	
BAR2	HNGS Detector 2 Barite Constant	1	
BHK	HNGS Borehole Potassium Correction Concentration	0	
BHS	Borehole Status	OPEN	
CSD1	Inner Casing Outer Diameter	0	IN
CSD2	Outer Casing Outer Diameter	0	IN
CSW1	Inner Casing Weight	0	LB/F
CSW2	Outer Casing Weight	0	LB/F

CSWZ	Outer Casing Weight	0	LB/F
DBCC	HNGS Barite Constant Correction Flag	NONE	
GCSE	Generalized Caliper Selection	BS	
H1P	HNGS Detector 1 Allow/Disallow In Processing	ALLOW	
H2P	HNGS Detector 2 Allow/Disallow In Processing	ALLOW	
HABK	HNGS Borehole Potassium Running Average	-0.0012706	
HALF	HNGS Alpha Filter Length	60	IN
HCRB	HNGS Apply Borehole Potassium Correction	NONE	
HMWM	Mud Weighting Material	NATU	
HNPE	HNGS Processing Enable	YES	
S1BI	HNGS Detector 1 Calibration Bismuth Count Rate	1.3	CPS
S2BI	HNGS Detector 2 Calibration Bismuth Count Rate	1.3	CPS
SGRC	HNGS Standard Gamma-Ray Correction Flag	YES	
TPOS	Tool Position	CENT	
VBA1	HNGS Detector 1 Variable Barite Factor Running Average	0.991683	
VBA2	HNGS Detector 2 Variable Barite Factor Running Average	0.994182	
EDTC-B: Enhanced DTS Cartridge			
BHS	Borehole Status	OPEN	
GCSE	Generalized Caliper Selection	BS	
System and Miscellaneous			
BS	Bit Size	9.875	IN
DFD	Drilling Fluid Density	1.03	G/C3
DO	Depth Offset for Playback	-4251.0	M
PP	Playback Processing	NORMAL	

Format: DSST\_P\_S\_UPPER\_VDL\_COLOR    Vertical Scale: 1:200    Graphics File Created: 17-Mar-2014 14:43

### OP System Version: 19C0-187

MEST-B	19C0-187	DTA-A	8453
DSST-B	19C0-187	HNGC-B	19C0-187
HNGS-BA	19C0-187	EDTC-B	SKK-5169-EDTCB

#### Input DLIS Files

DEFAULT	FMS_DSI_NGS_037PUP	FN:59	PRODUCER	18-Feb-2014 04:12	4702.3 M	4242.8 M
---------	--------------------	-------	----------	-------------------	----------	----------

#### Output DLIS Files

DEFAULT	FMS_DSI_NGS_061PUP	FN:81	PRODUCER	17-Mar-2014 14:43		
---------	--------------------	-------	----------	-------------------	--	--

Company: Lamont Doherty Earth Observatory    Well: Expedition 349, Site U1431

#### Input DLIS Files

DEFAULT	FMS_DSI_NGS_036PUP	FN:58	PRODUCER	18-Feb-2014 04:10	4672.6 M	4454.3 M
---------	--------------------	-------	----------	-------------------	----------	----------

#### Output DLIS Files

DEFAULT	FMS_DSI_NGS_060PUP	FN:80	PRODUCER	17-Mar-2014 14:28	421.4 M	203.3 M
---------	--------------------	-------	----------	-------------------	---------	---------

### OP System Version: 19C0-187

MEST-B	19C0-187	DTA-A	8453
DSST-B	19C0-187	HNGC-B	19C0-187
HNGS-BA	19C0-187	EDTC-B	SKK-5169-EDTCB

#### PIP SUMMARY

Time Mark Every 60 S

HNGS Spectroscopy Gamma Ray (HSGR)		
0	(GAPI)	100
Waveform Data Copy Indicator 4 - Monopole P&S (WCI4)		
0	(----	10
Peak Coherence / RA - P & S Shear (CHRS)		
-1	(----	9
Peak Coherence / RA - P & S Comp		

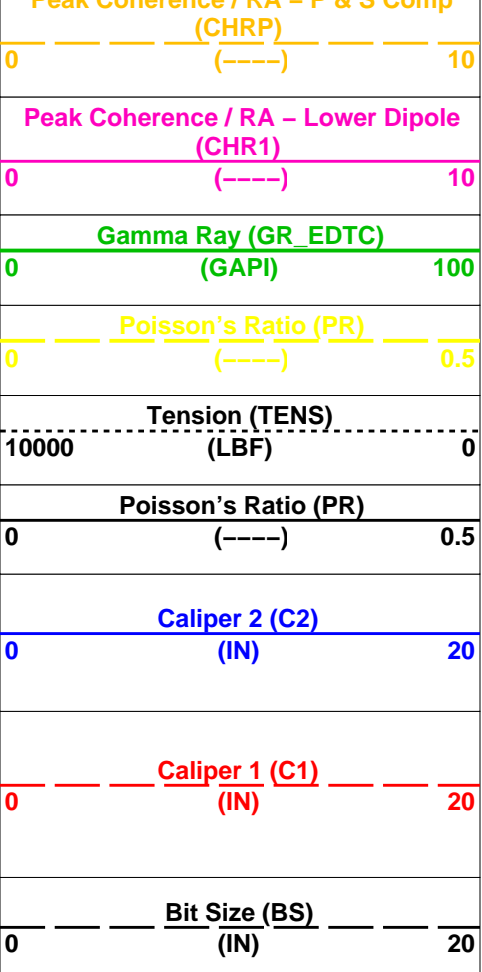

Uplong #1 SAM1 LFD, SAM2, SAM4 LFD

Sea Floor Depth Reference

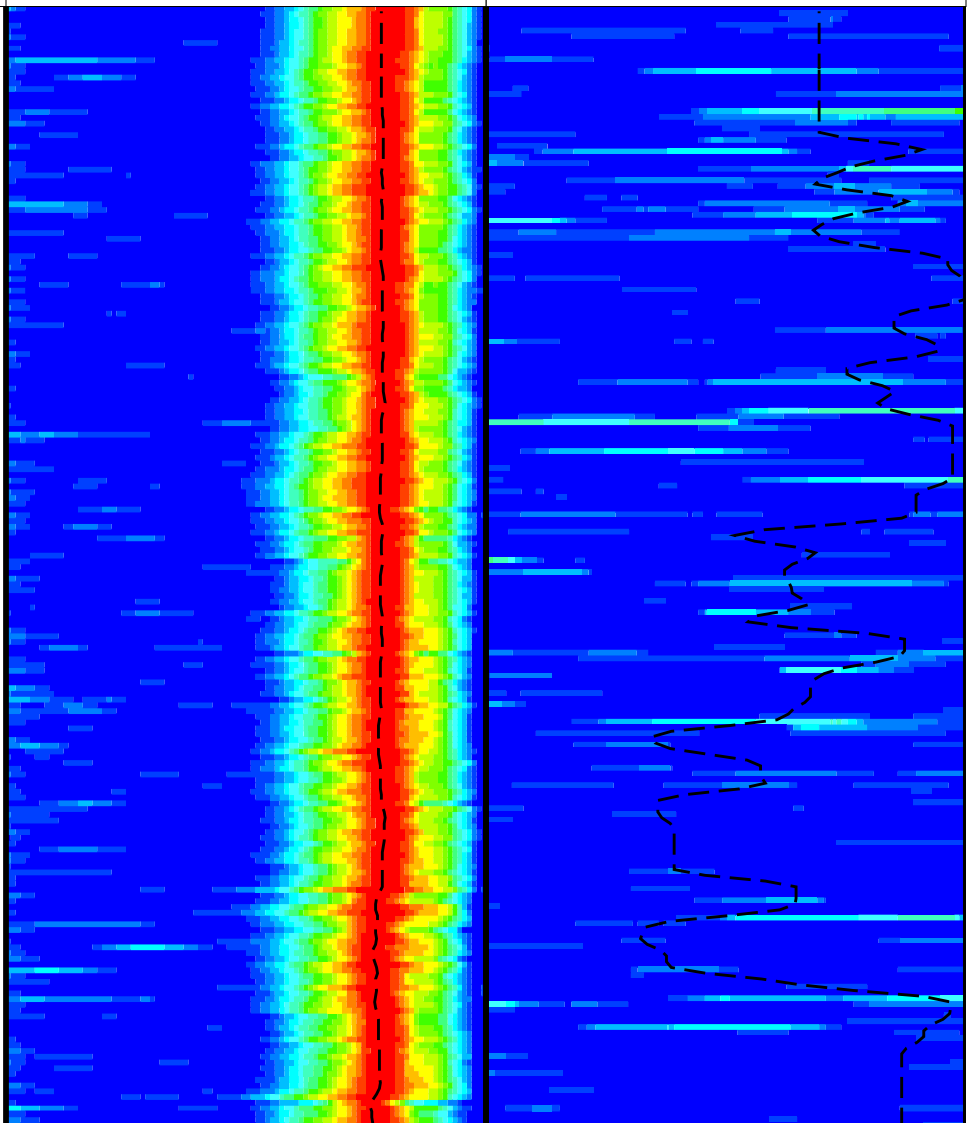
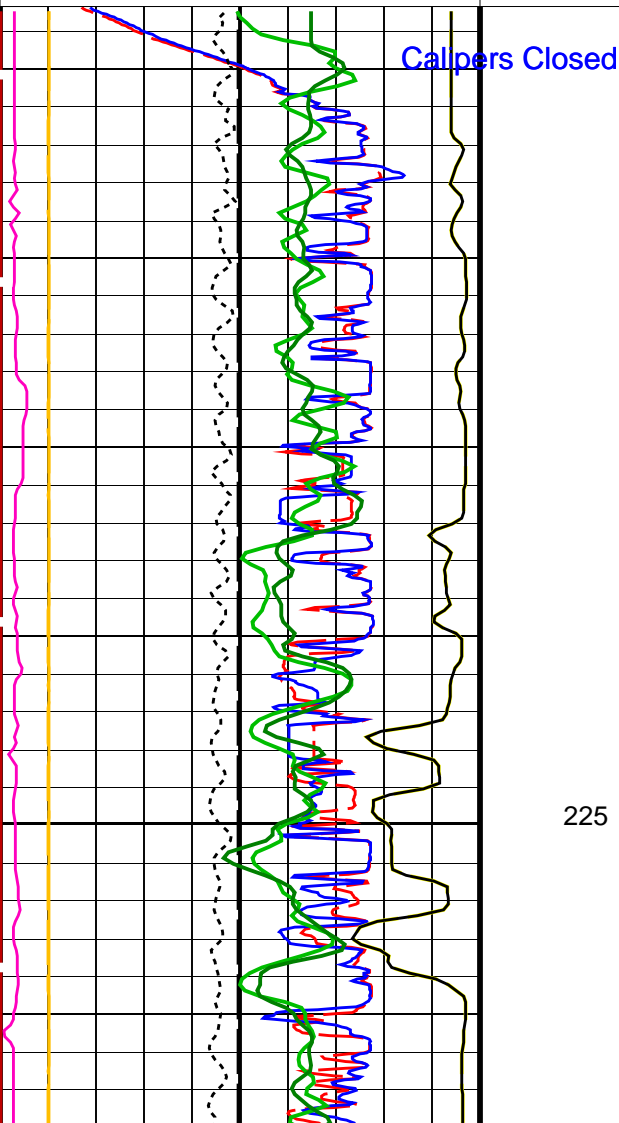
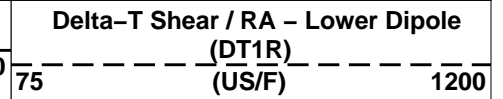
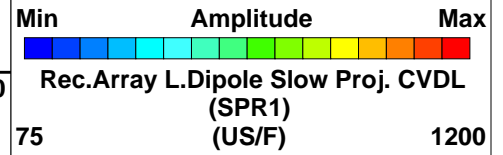
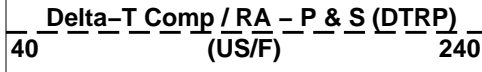
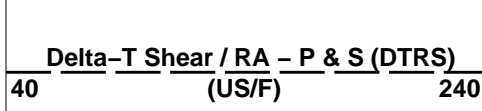
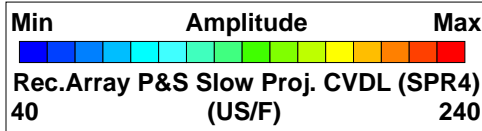

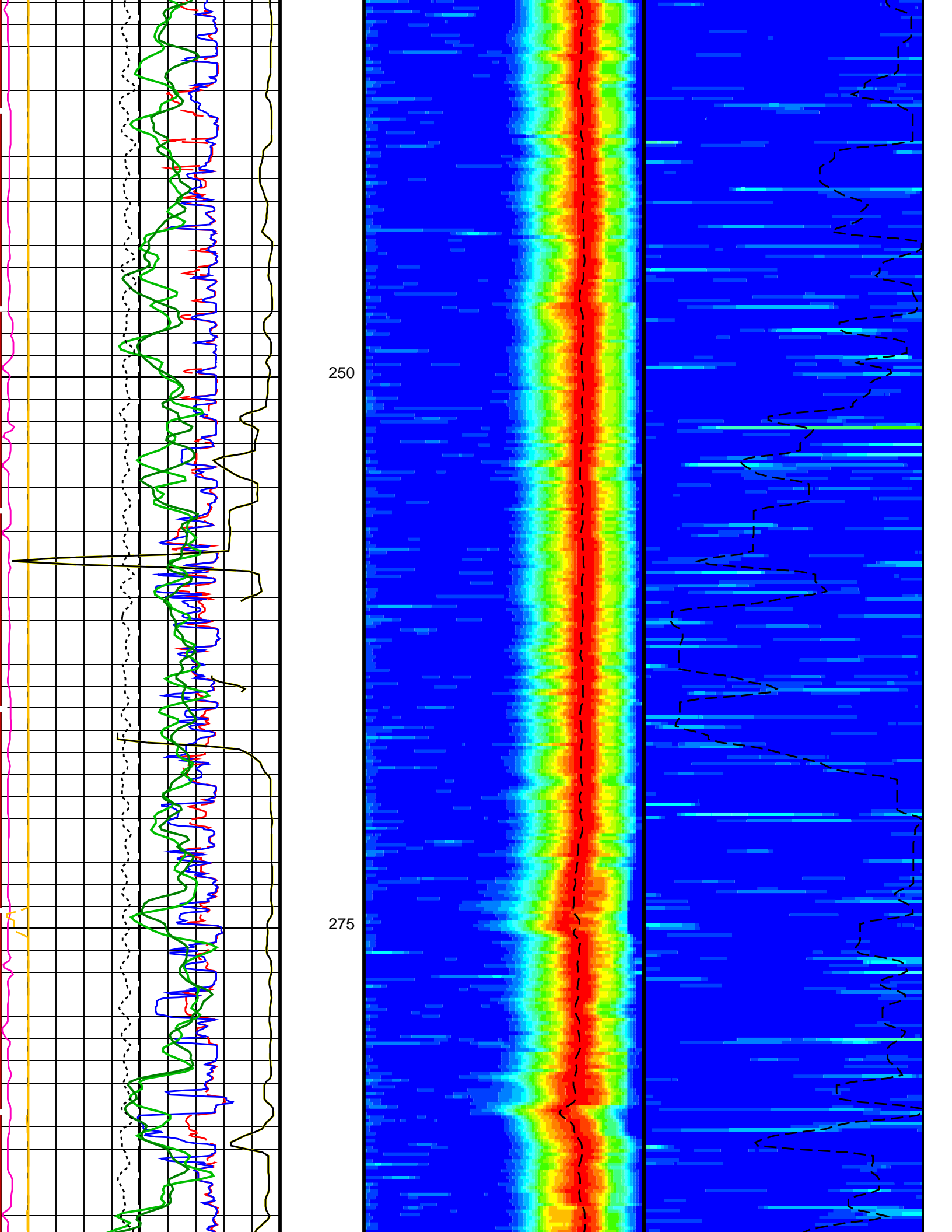

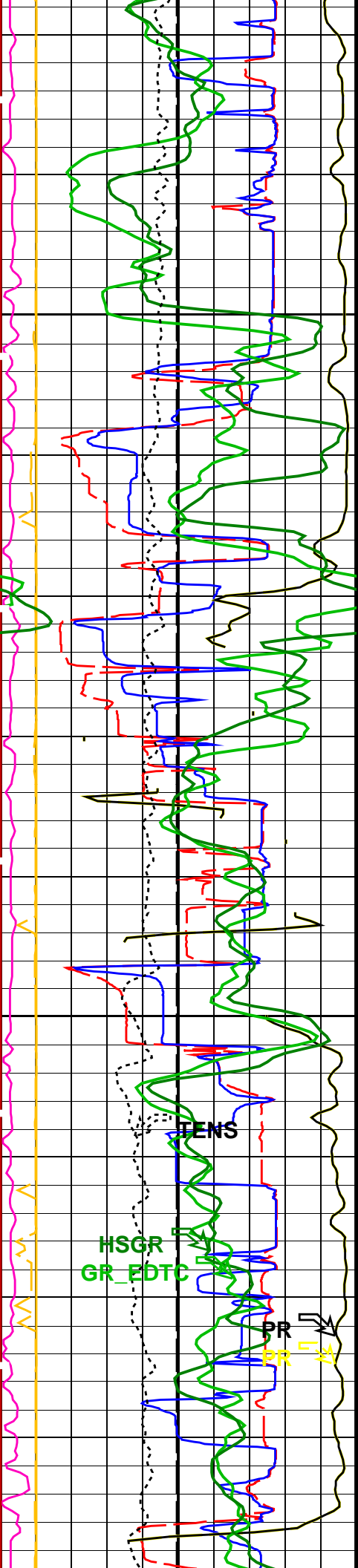

300

325

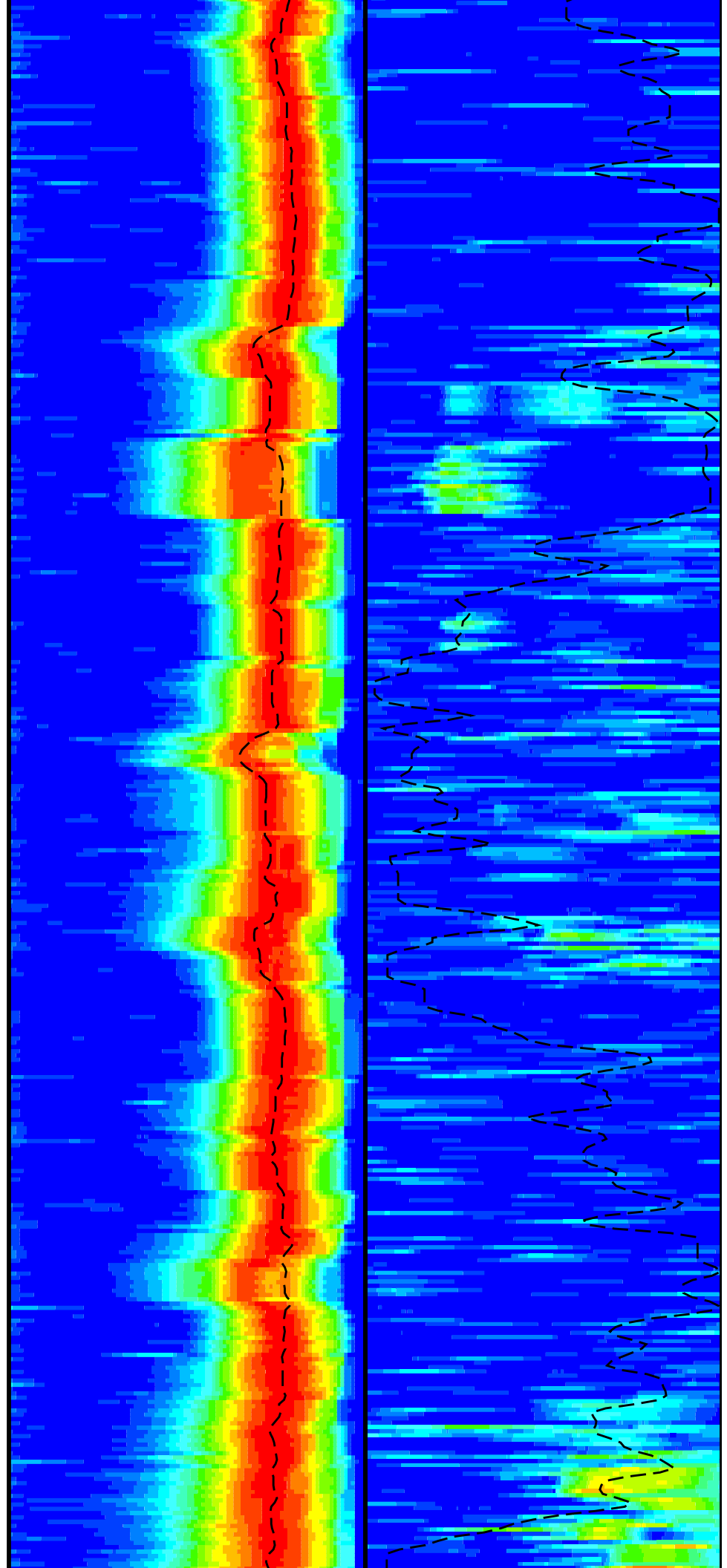

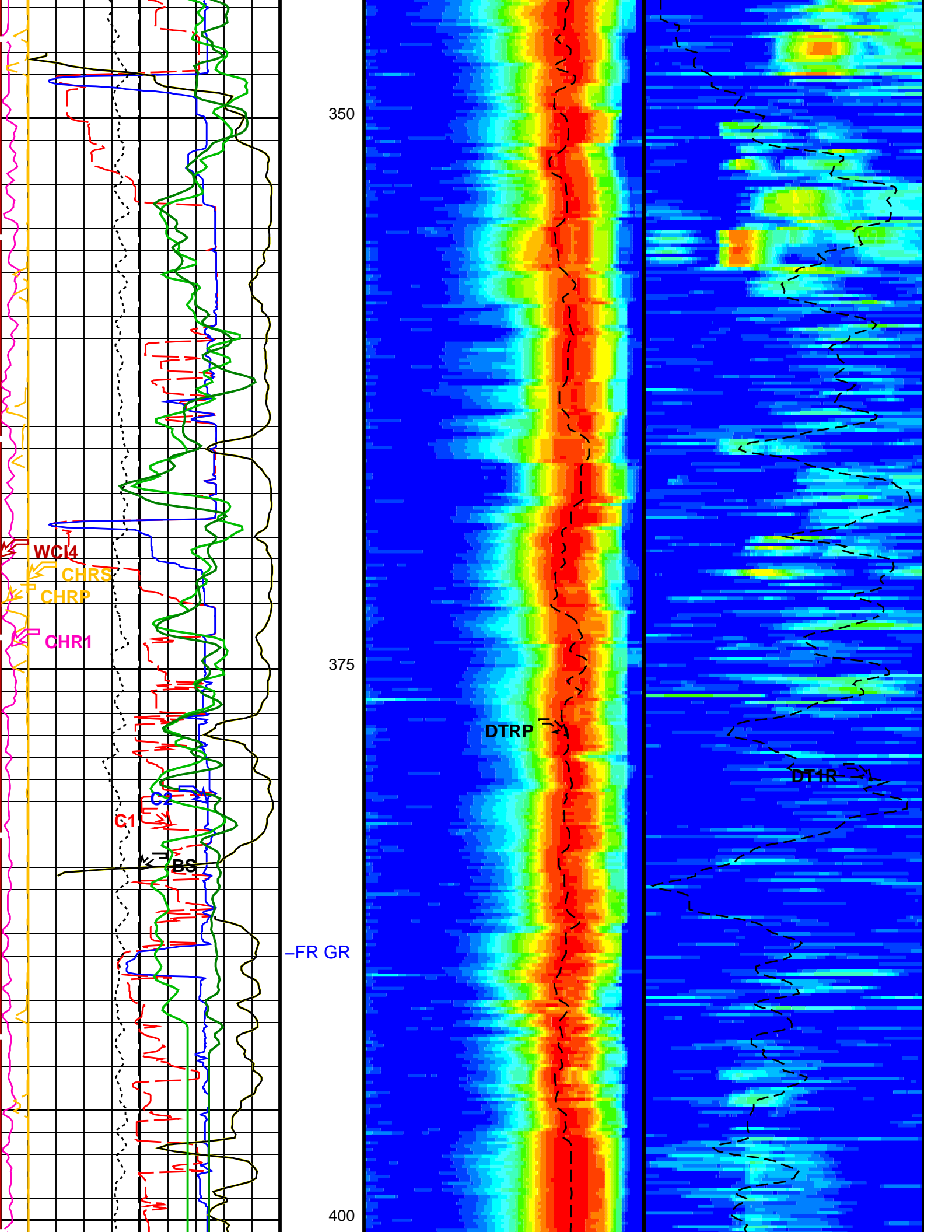



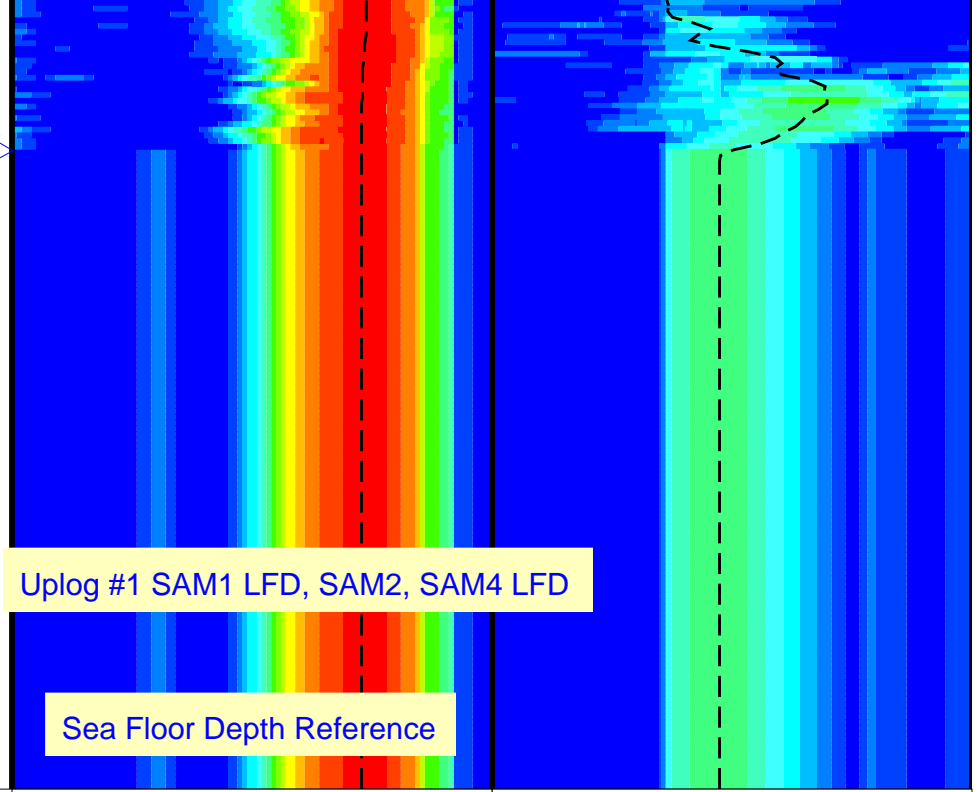
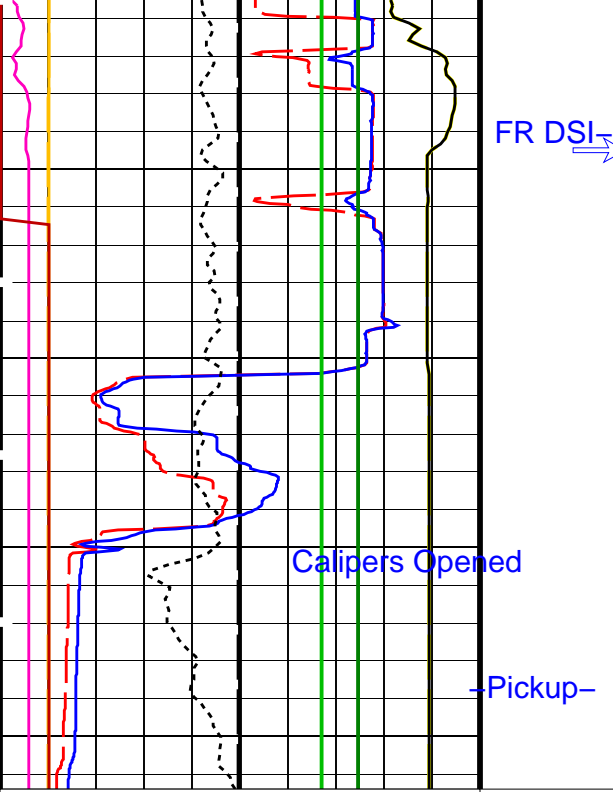

Bit Size (BS) (IN)	0	20
Caliper 1 (C1) (IN)	0	20
Caliper 2 (C2) (IN)	0	20
Poisson's Ratio (PR) (----	0	0.5
Tension (TENS) (LBF)	10000	0
Poisson's Ratio (PR) (----	0	0.5
Gamma Ray (GR_EDTC) (GAPI)	0	100
Peak Coherence / RA - Lower Dipole (CHR1) (----	0	10
Peak Coherence / RA - P & S Comp (CHRP) (----	0	10
Peak Coherence / RA - P & S Shear (CHRS) (----	-1	9
Waveform Data Copy Indicator 4 - Monopole P&S (WCI4) (----	0	10
HNGS Spectroscopy Gamma Ray (HSGR)		

Delta-T Comp / RA - P & S (DTRP) (US/F)	40	240
Delta-T Shear / RA - Lower Dipole (DT1R) (US/F)	75	1200
Delta-T Shear / RA - P & S (DTRS) (US/F)	40	240
Rec.Array L.Dipole Slow Proj. CVDL (SPR1) (US/F)	75	1200
Rec.Array P&S Slow Proj. CVDL (SPR4) (US/F)	40	240



## PIP SUMMARY

Time Mark Every 60 S

## Parameters

DLIS Name	Description	Value	
DSST-B: Dipole Shear Imager - B			
BHS	Borehole Status	OPEN	
CASF	Label Casing Function - Monopole P&S	50	
COLL	Label Slowness Lower Limit - Monopole P&S Compressional	60	US/F
COUL	Label Slowness Upper Limit - Monopole P&S Compressional	209	US/F
DDE1	Digitizing Delay 1	0	US
DDE4	Digitizing Delay 4	0	US
DDEX	Digitizing Delay X	0	US
DLCS	Label Compressional Source - Dipole Shear	USE	
DSHL	Label Slowness Lower Limit - Dipole Shear	75	US/F
DSHU	Label Slowness Upper Limit - Dipole Shear	1200	US/F
DSI1	Digitizer Sample Interval 1	40	US
DSI4	Digitizer Sample Interval 4	10	US
DSIX	Digitizer Sample Interval X	40	US
DTCS	Compressional Delta-T Source for DTCS Channel	PS_COMP	
DTF	Delta-T Fluid	210	US/F
DTSS	Shear Delta-T Source for DTSM Channel	LOWER_DIPOLE	
DWC1	Digitizer Word Count 1	512	
DWC4	Digitizer Word Count 4	512	
DWCX	Digitizer Word Count X	512	
FILG	Label Fill Gap Control - Monopole P&S	COMP	
GCSE	Generalized Caliper Selection	BS	
LFC	Label Formation Character - Monopole P&S	COMP_FIRST	
LTXG	Lower Dipole Transmitter Geometry	156	IN
MCS	Mean Casing Slowness	57	US/F
MTXG	Monopole Transmitter Geometry	186	IN
NWI1	Number Waveform Items 1	8	
NWI4	Number Waveform Items 4	8	
NWIX	Number Waveform Items X	0	
RSMN	Label Shear/Compressional Minimum Ratio - Monopole P&S	1.4	
RSMX	Label Shear/Compressional Maximum Ratio - Monopole P&S	2.12	
RX1G	Receiver 1 Geometry	294	IN
RX2G	Receiver 2 Geometry	300	IN
RX3G	Receiver 3 Geometry	306	IN
RX4G	Receiver 4 Geometry	312	IN
RX5G	Receiver 5 Geometry	318	IN
RX6G	Receiver 6 Geometry	324	IN
RX7G	Receiver 7 Geometry	330	IN
RX8G	Receiver 8 Geometry	336	IN
SAM1	DSST Sonic Acquisition Mode 1 - Lower Dipole Mode	LFD_EVEN	
SAM4	DSST Sonic Acquisition Mode 4 - Monopole Mode for P&S	LFD_EVEN	
SAMX	DSST Sonic Acquisition Mode X - Both Dipoles or Monopole Mode for Expert	OFF	
SAS1	STC Sonic Array Status - Lower Dipole	255	
SAS4	STC Sonic Array Status - Monopole P&S	255	
SBO1	STC Search Band Offset - Lower Dipole	300	US
SBO4	STC Search Band Offset - Monopole P&S	500	US
SBR4	STC Baseline Removal - Monopole P&S	ON	
SBW1	STC Search Bandwidth - Lower Dipole	8000	US
SBW4	STC Search Bandwidth - Monopole P&S	2000	US
SFC1	STC Formation Character - Lower Dipole	SELECTABLE	
SFC4	STC Formation Character - Monopole P&S	SELECTABLE	
SFM1	STC Filter - Lower Dipole	B.3-1.5K	
SFM4	STC Filter - Monopole P&S	B3-12K	
SHLL	Label Slowness Lower Limit - Monopole P&S Shear	235	US/F
SHUL	Label Slowness Upper Limit - Monopole P&S Shear	240	US/F
SLL1	STC Slowness Lower Limit - Lower Dipole	75	US/F
SLL4	STC Slowness Lower Limit - Monopole P&S	40	US/F
SST1	STC Slowness Step - Lower Dipole	4	US/F
SST4	STC Slowness Step - Monopole P&S	2	US/F
SSW1	STC Source Waveform - Lower Dipole	WF_SAM1	
SSW4	STC Source Waveform - Monopole P&S	WF_SAM4	
STLL	Label Slowness Lower Limit - Monopole Stoneley	180	US/F
STUL	Label Slowness Upper Limit - Monopole Stoneley	1200	US/F
SUL1	STC Slowness Upper Limit - Lower Dipole	1200	US/F
SUL4	STC Slowness Upper Limit - Monopole P&S	240	US/F
SWD1	STC Slowness Width - Lower Dipole	40	US/F
SWD4	STC Slowness Width - Monopole P&S	10	US/F
TBF1	STC Time for Baseline Fill - Lower Dipole	0	US
TBF4	STC Time for Baseline Fill - Monopole P&S	300	US
TLL1	STC Time Lower Limit - Lower Dipole	600	US
TLL4	STC Time Lower Limit - Monopole P&S	150	US
TST1	STC Time Step - Lower Dipole	200	US
TST4	STC Time Step - Monopole P&S	50	US

TUL1	STC Time Upper Limit - Lower Dipole	20440	US
TUL4	STC Time Upper Limit - Monopole P&S	3660	US
TWD1	STC Time Width - Lower Dipole	2000	US
TWD4	STC Time Width - Monopole P&S	1000	US
TWI1	STC Integration Time Window - Lower Dipole	1600	US
TWI4	STC Integration Time Window - Monopole P&S	500	US
TWSX	Transmitter Waveform Select X	0	
WFM4	Waveform Mode 4	W1	
<b>HNGS-BA: Hostile Natural Gamma Ray Sonde</b>			
BAR1	HNGS Detector 1 Barite Constant	1	
BAR2	HNGS Detector 2 Barite Constant	1	
BHK	HNGS Borehole Potassium Correction Concentration	0	
BHS	Borehole Status	OPEN	
CSD1	Inner Casing Outer Diameter	0	IN
CSD2	Outer Casing Outer Diameter	0	IN
CSW1	Inner Casing Weight	0	LB/F
CSW2	Outer Casing Weight	0	LB/F
DBCC	HNGS Barite Constant Correction Flag	NONE	
GCSE	Generalized Caliper Selection	BS	
H1P	HNGS Detector 1 Allow/Disallow In Processing	ALLOW	
H2P	HNGS Detector 2 Allow/Disallow In Processing	ALLOW	
HABK	HNGS Borehole Potassium Running Average	-0.00178767	
HALF	HNGS Alpha Filter Length	60	IN
HCRB	HNGS Apply Borehole Potassium Correction	NONE	
HMWM	Mud Weighting Material	NATU	
HNPE	HNGS Processing Enable	YES	
S1BI	HNGS Detector 1 Calibration Bismuth Count Rate	1.3	CPS
S2BI	HNGS Detector 2 Calibration Bismuth Count Rate	1.3	CPS
SGRC	HNGS Standard Gamma-Ray Correction Flag	YES	
TPOS	Tool Position	CENT	
VBA1	HNGS Detector 1 Variable Barite Factor Running Average	1.04423	
VBA2	HNGS Detector 2 Variable Barite Factor Running Average	1.01776	
<b>EDTC-B: Enhanced DTS Cartridge</b>			
BHS	Borehole Status	OPEN	
GCSE	Generalized Caliper Selection	BS	
<b>System and Miscellaneous</b>			
BS	Bit Size	9.875	IN
DFD	Drilling Fluid Density	1.03	G/C3
DO	Depth Offset for Playback	-4251.0	M
PP	Playback Processing	NORMAL	

Format: DSST\_P\_S\_LOWER\_VDL\_COLOR    Vertical Scale: 1:200    Graphics File Created: 17-Mar-2014 14:28

### OP System Version: 19C0-187

MEST-B	19C0-187	DTA-A	8453
DSST-B	19C0-187	HNGC-B	19C0-187
HNGS-BA	19C0-187	EDTC-B	SKK-5169-EDTCB

#### Input DLIS Files

DEFAULT	FMS_DSI_NGS_036PUP	FN:58	PRODUCER	18-Feb-2014 04:10	4672.6 M	4454.3 M
---------	--------------------	-------	----------	-------------------	----------	----------

#### Output DLIS Files

DEFAULT	FMS_DSI_NGS_060PUP	FN:80	PRODUCER	17-Mar-2014 14:28
---------	--------------------	-------	----------	-------------------

Company: Lamont Doherty Earth Observatory

Well: Expedition 349, Site U1431

#### Input DLIS Files

DEFAULT	FMS_DSI_NGS_036PUP	FN:58	PRODUCER	18-Feb-2014 04:10	4672.6 M	4454.3 M
---------	--------------------	-------	----------	-------------------	----------	----------

#### Output DLIS Files

DEFAULT	FMS_DSI_NGS_060PUP	FN:80	PRODUCER	17-Mar-2014 14:28	421.4 M	203.3 M
---------	--------------------	-------	----------	-------------------	---------	---------

### OP System Version: 19C0-187

MEST-B	19C0-187	DTA-A	8453
DSST-B	19C0-187	HNGC-B	19C0-187
HNGS-BA	19C0-187	EDTC-B	SKK-5169-EDTCB

<b>HNGS Spectroscopy Gamma Ray (HSGR)</b>		
0	(GAPI)	100
<b>Waveform Data Copy Indicator 4 - Monopole P&amp;S (WCI4)</b>		
0	(----)	10
<b>Peak Coherence / RA - P &amp; S Shear (CHRS)</b>		
-1	(----)	9
<b>Peak Coherence / RA - P &amp; S Comp (CHRP)</b>		
0	(----)	10
<b>Peak Coherence / RA - Upper Dipole (CHR2)</b>		
0	(----)	10
<b>Gamma Ray (GR_EDTC)</b>		
0	(GAPI)	100
<b>Poisson's Ratio (PR)</b>		
0	(----)	0.5
<b>Poisson's Ratio (PR)</b>		
0	(----)	0.5

SAM1 LFD, SAM2, SAM 4 LFD

1st Pass, Sea Floor Depth Reference

<b>Caliper 1 (C1)</b>		
0	(IN)	20
<b>Caliper 2 (C2)</b>		
0	(IN)	20
<b>Bit Size (BS)</b>		
0	(IN)	20

Calibrated Downhole Force (CDF) (LBF)	5000	0
	10000	0
Tension (TENS) (LBF)	5000	0
	10000	0

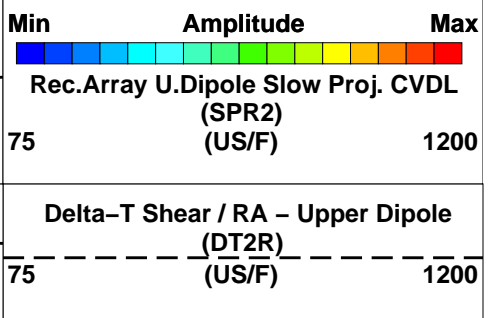
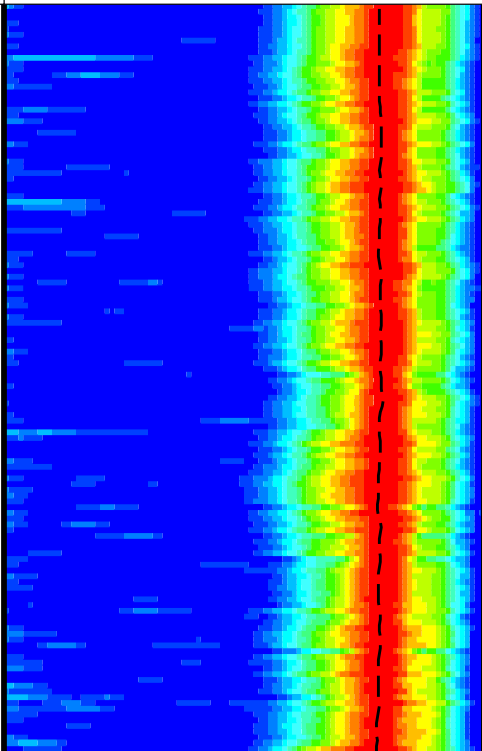
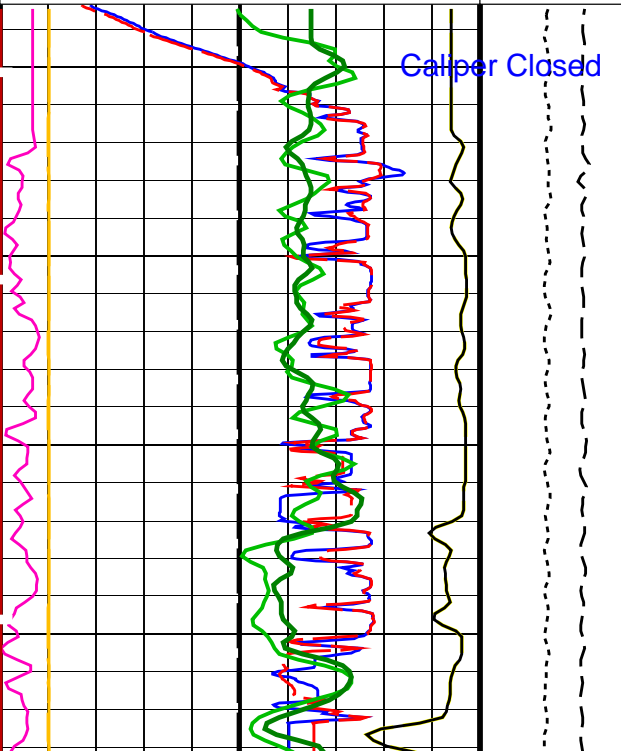
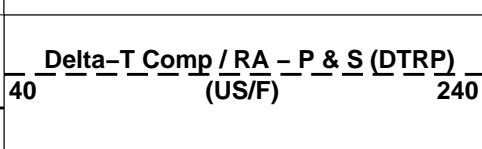
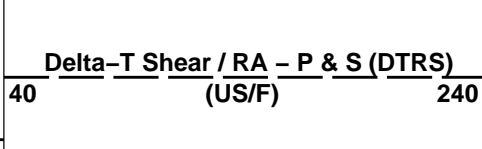
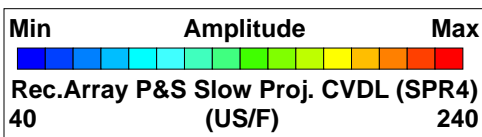

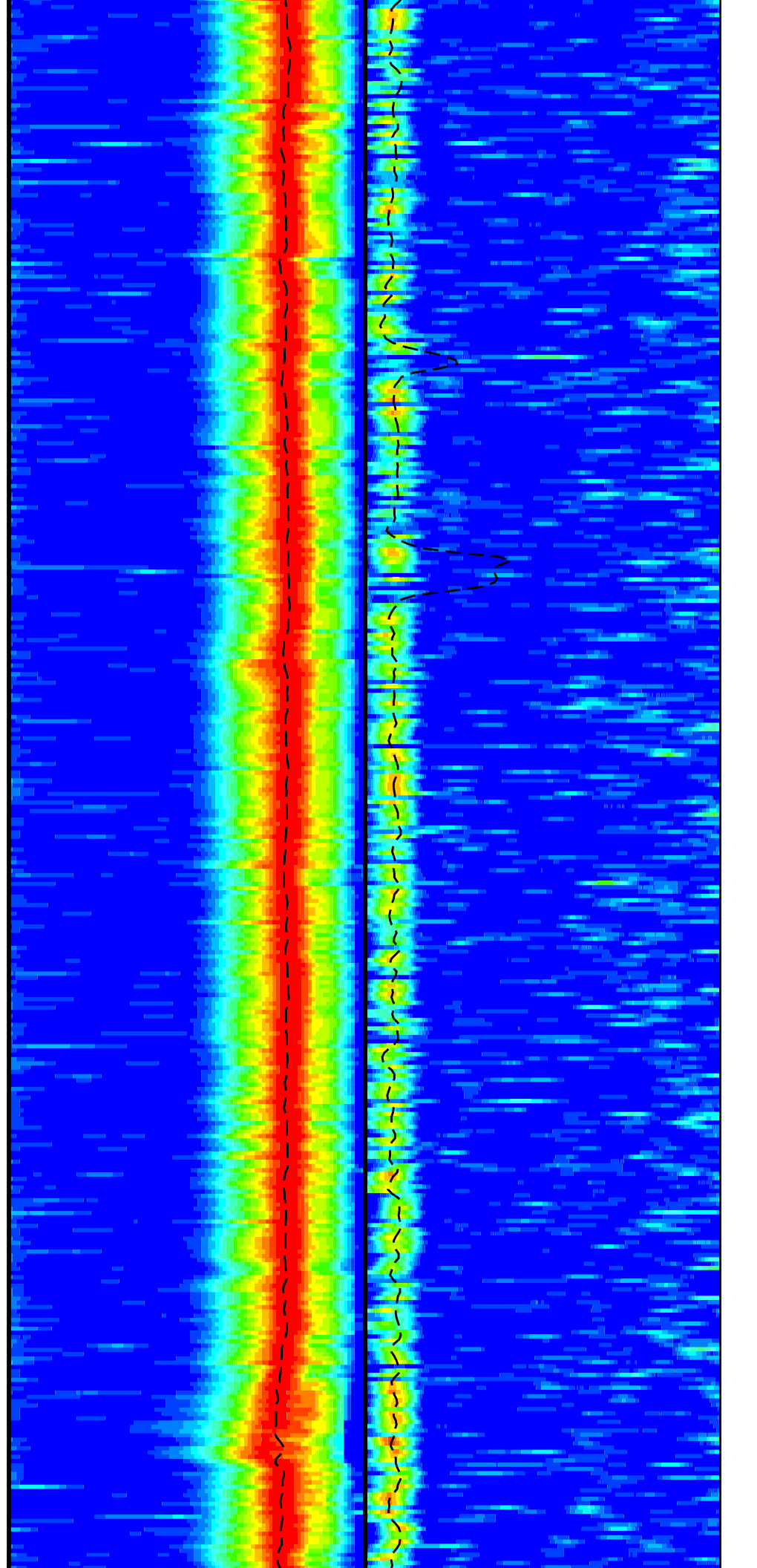
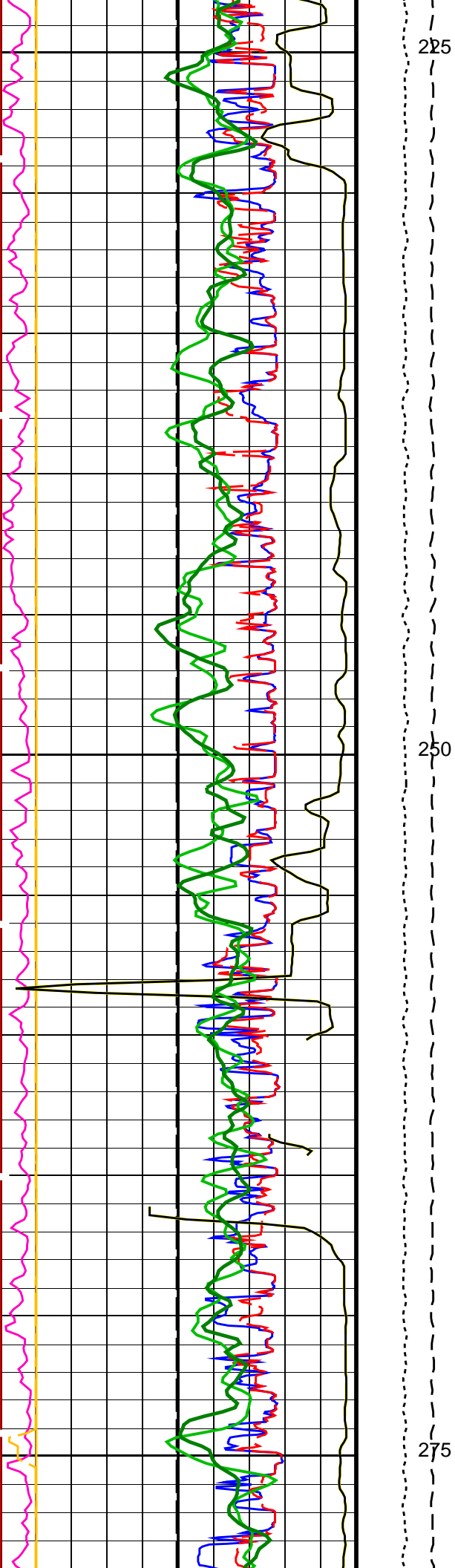

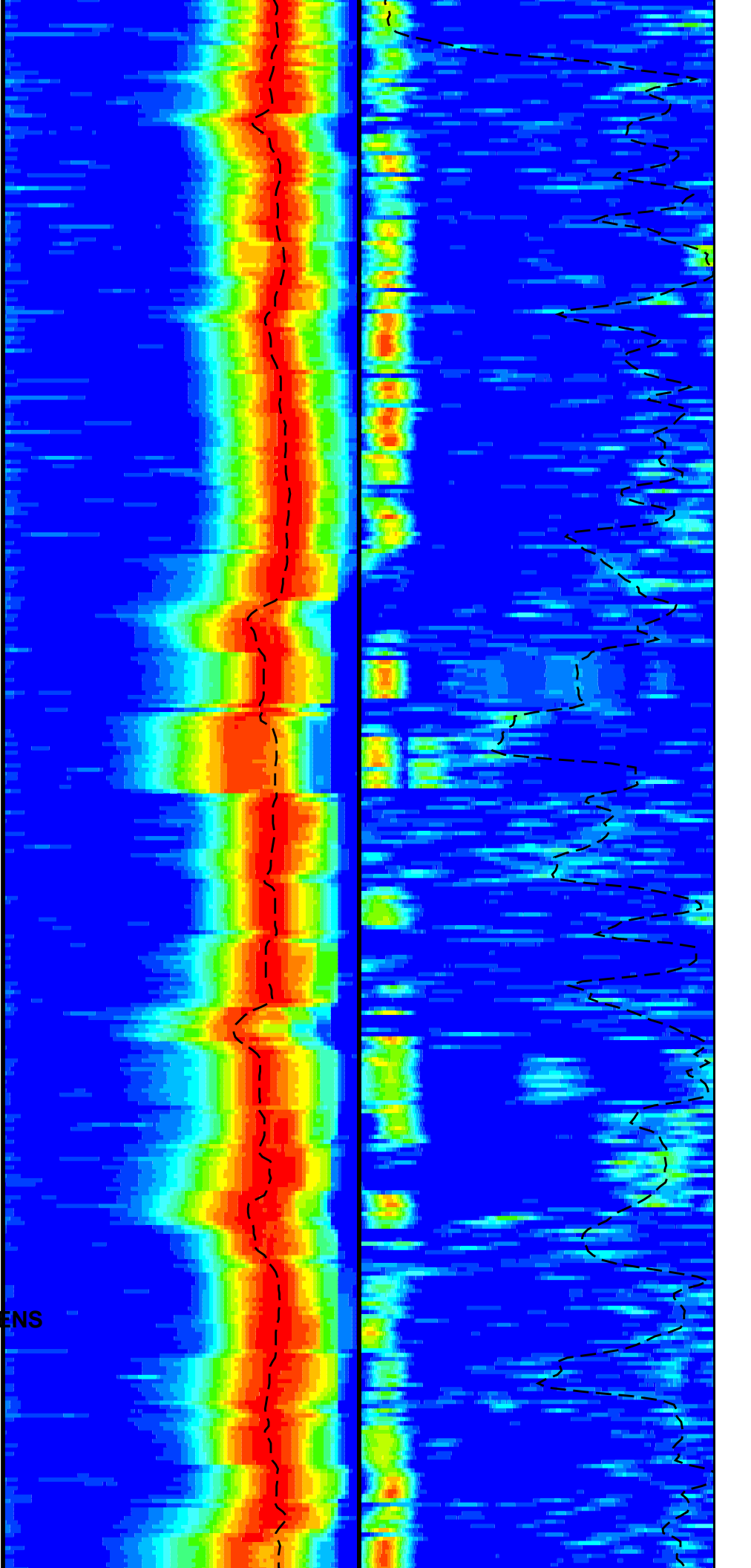
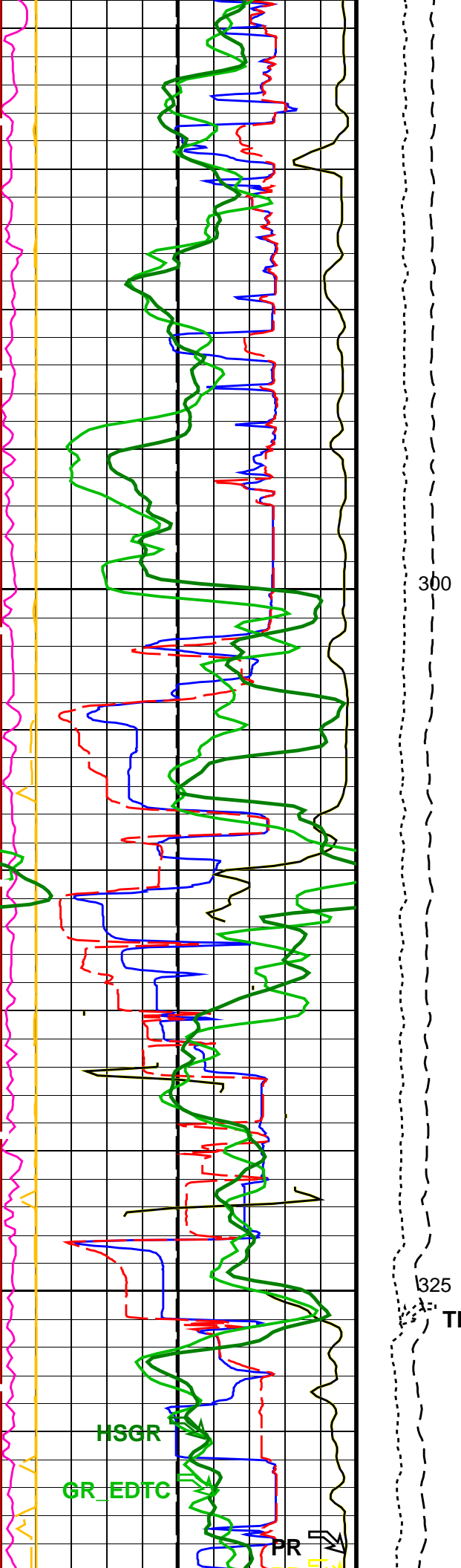

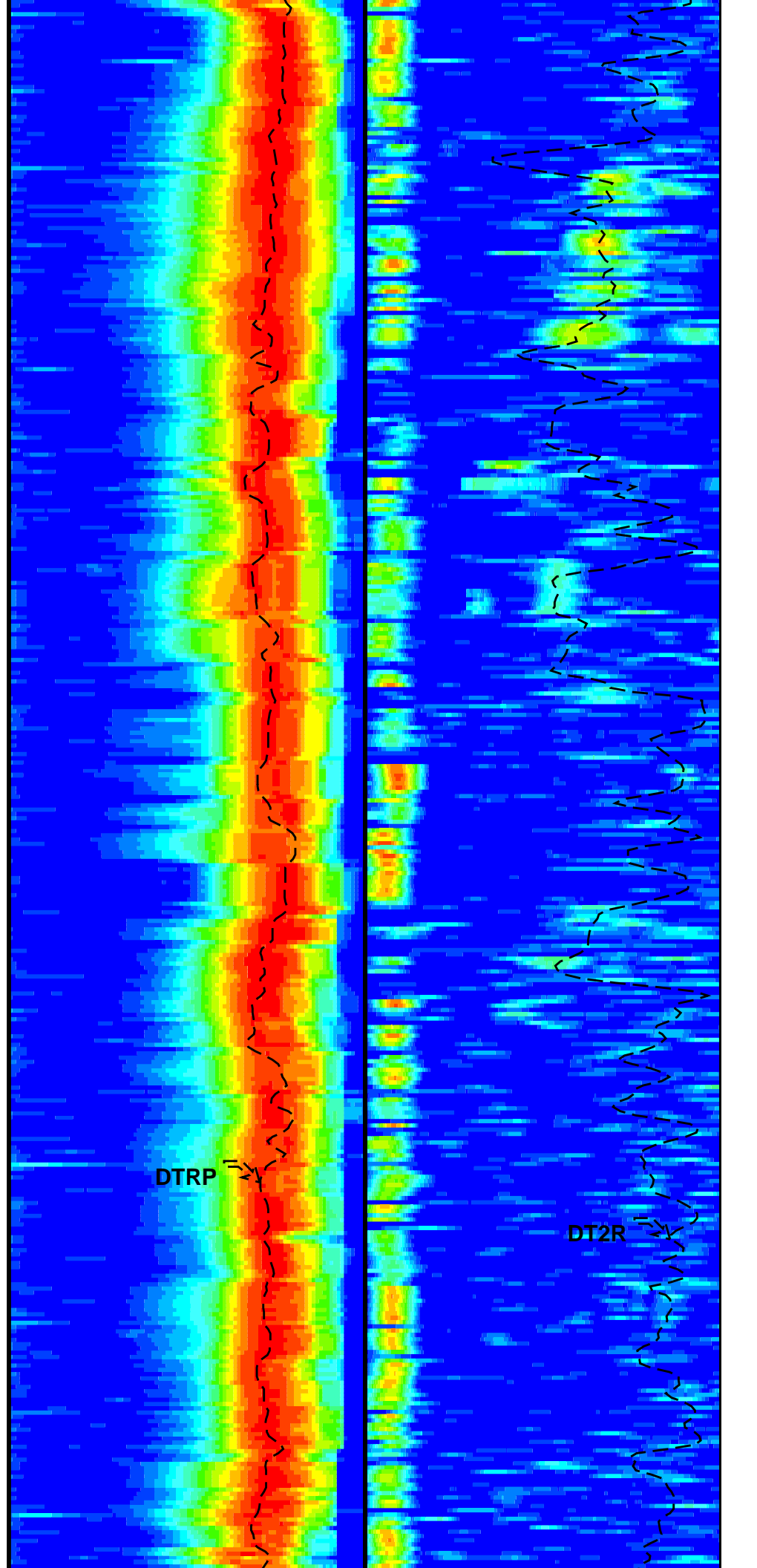
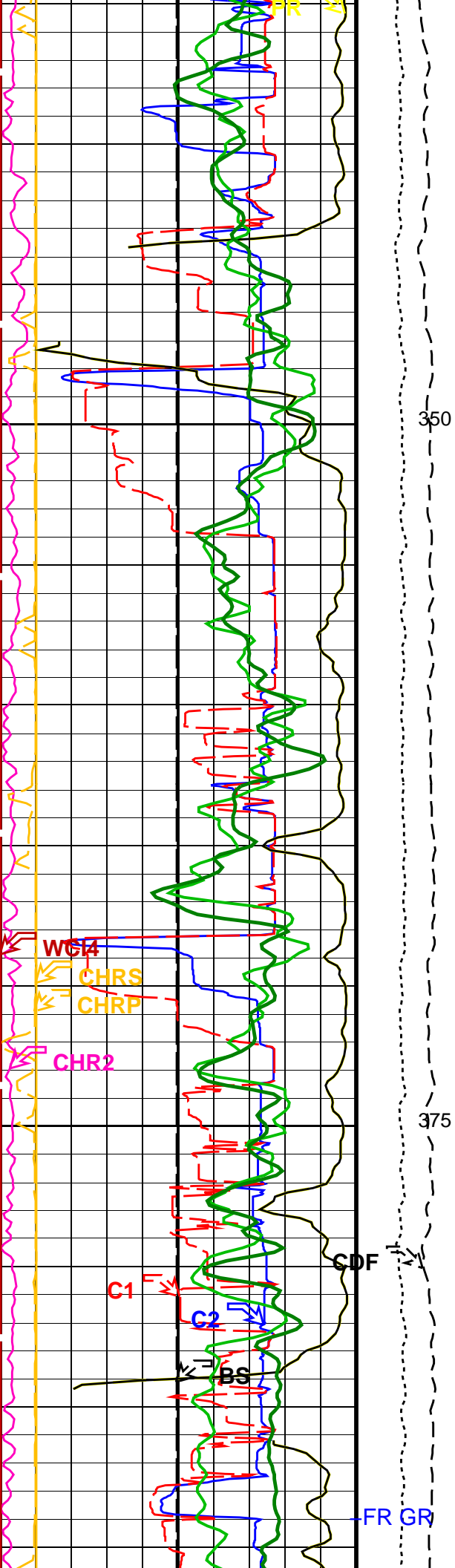

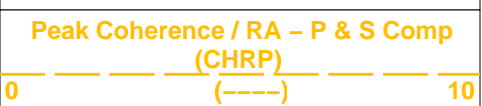
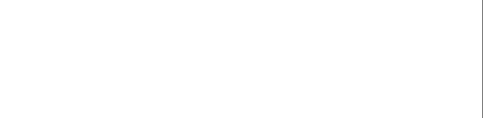
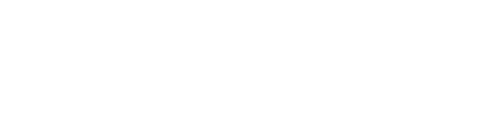
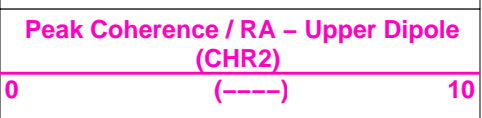
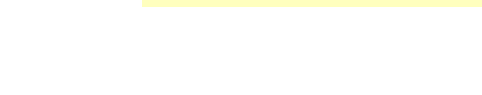
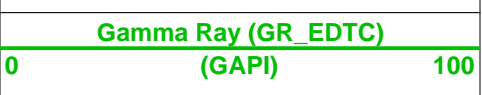
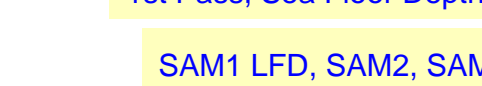
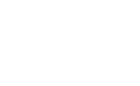
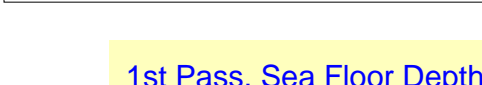
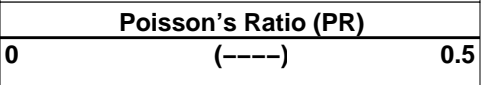
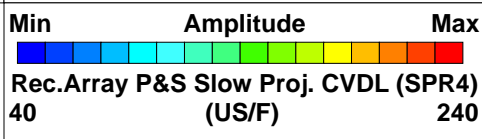
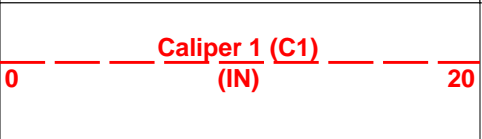
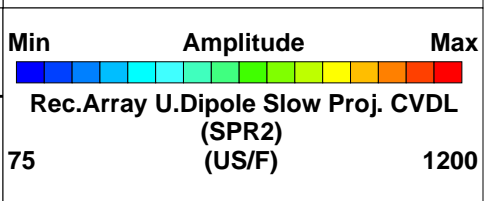
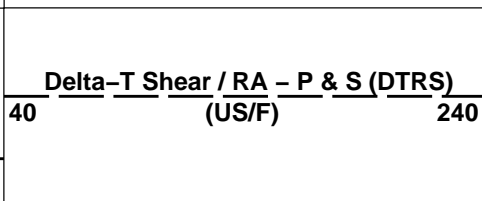
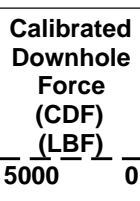
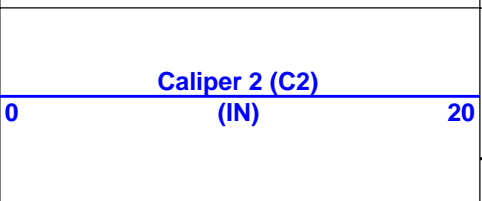
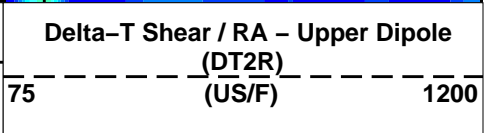
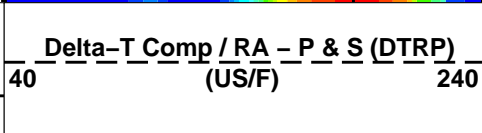
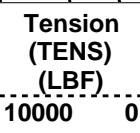
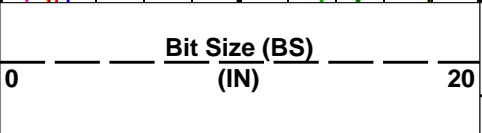
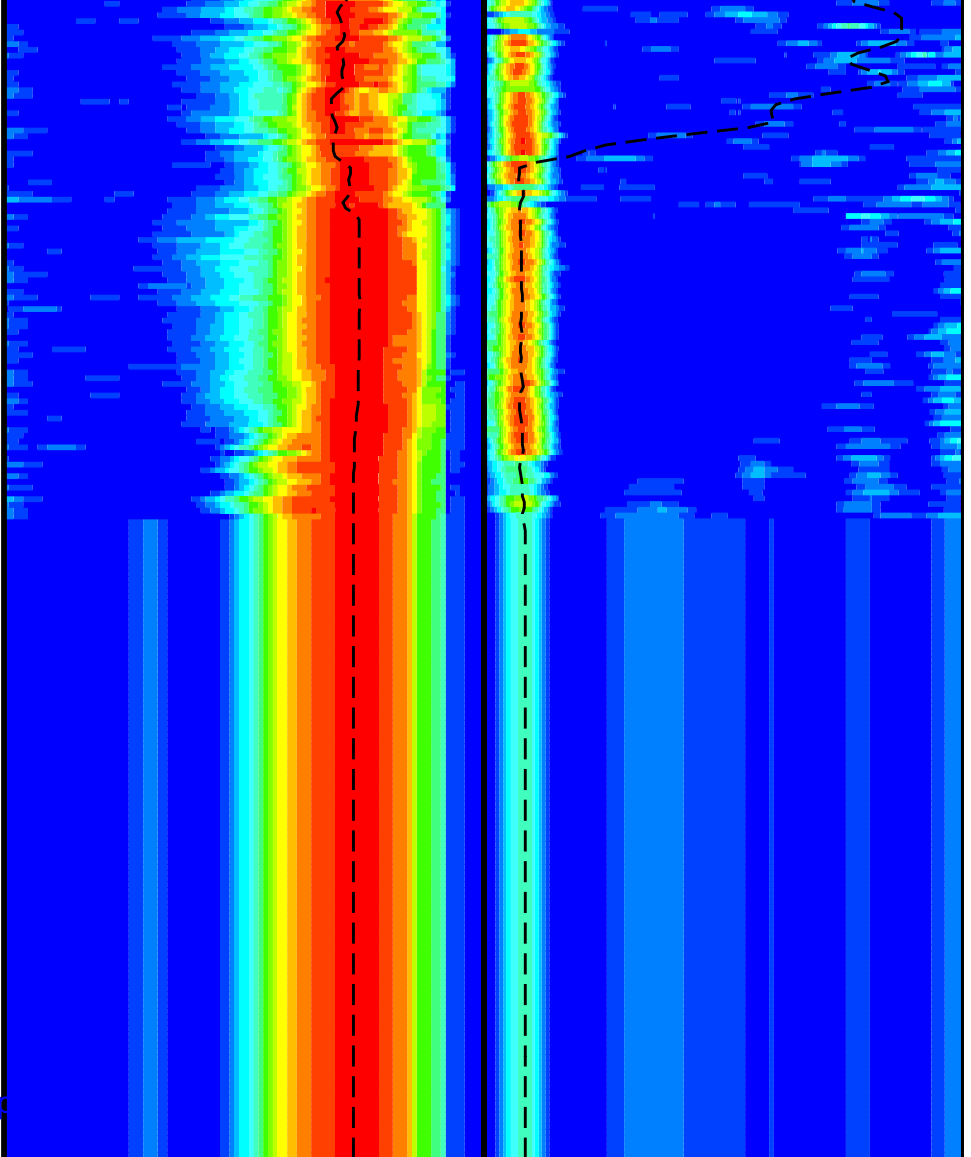
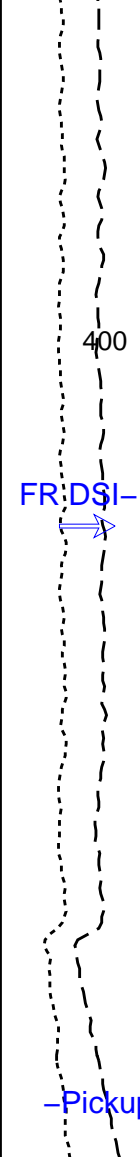
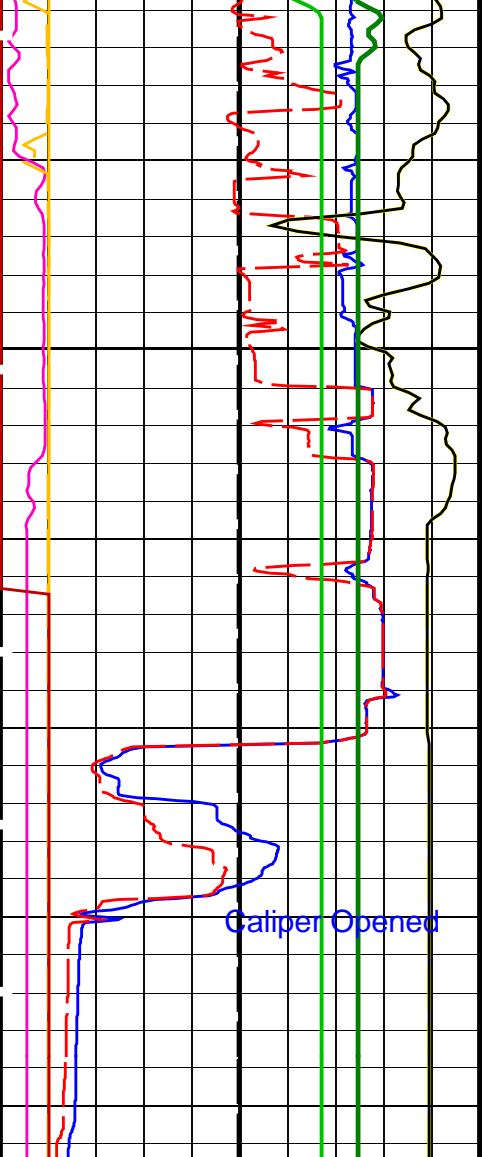

1st Pass, Sea Floor Depth Reference

SAM1 LFD, SAM2, SAM 4 LFD



Peak Coherence / RA – P & S Shear (CHRS)	-1 (----)	9
Waveform Data Copy Indicator 4 – Monopole P&S (WCI4)	0 (----)	10
HNGS Spectroscopy Gamma Ray (HSGR)	0 (GAPI)	100

PIP SUMMARY

Time Mark Every 60 S

Parameters

DLIS Name	Description	Value	
DSST-B: Dipole Shear Imager – B			
BHS	Borehole Status	OPEN	
CASF	Label Casing Function – Monopole P&S	50	
COLL	Label Slowness Lower Limit – Monopole P&S Compressional	60	US/F
COUL	Label Slowness Upper Limit – Monopole P&S Compressional	209	US/F
DDE2	Digitizing Delay 2	0	US
DDE4	Digitizing Delay 4	0	US
DDEX	Digitizing Delay X	0	US
DLCS	Label Compressional Source – Dipole Shear	USE	
DSHL	Label Slowness Lower Limit – Dipole Shear	75	US/F
DSHU	Label Slowness Upper Limit – Dipole Shear	1200	US/F
DSI2	Digitizer Sample Interval 2	40	US
DSI4	Digitizer Sample Interval 4	10	US
DSIX	Digitizer Sample Interval X	40	US
DTCS	Compressional Delta-T Source for DTCO Channel	PS_COMP	
DTF	Delta-T Fluid	210	US/F
DTSS	Shear Delta-T Source for DTSM Channel	LOWER_DIPOLE	
DWC2	Digitizer Word Count 2	512	
DWC4	Digitizer Word Count 4	512	
DWCX	Digitizer Word Count X	512	
FILG	Label Fill Gap Control – Monopole P&S	COMP	
GCSE	Generalized Caliper Selection	BS	
LFC	Label Formation Character – Monopole P&S	COMP_FIRST	
MCS	Mean Casing Slowness	57	US/F
MTXG	Monopole Transmitter Geometry	186	IN
NWI2	Number Waveform Items 2	8	
NWI4	Number Waveform Items 4	8	
NWIX	Number Waveform Items X	0	
RSMN	Label Shear/Compressional Minimum Ratio – Monopole P&S	1.4	
RSMX	Label Shear/Compressional Maximum Ratio – Monopole P&S	2.12	
RX1G	Receiver 1 Geometry	294	IN
RX2G	Receiver 2 Geometry	300	IN
RX3G	Receiver 3 Geometry	306	IN
RX4G	Receiver 4 Geometry	312	IN
RX5G	Receiver 5 Geometry	318	IN
RX6G	Receiver 6 Geometry	324	IN
RX7G	Receiver 7 Geometry	330	IN
RX8G	Receiver 8 Geometry	336	IN
SAM2	DSST Sonic Acquisition Mode 2 – Upper Dipole Mode	ODD	
SAM4	DSST Sonic Acquisition Mode 4 – Monopole Mode for P&S	LFD_EVEN	
SAMX	DSST Sonic Acquisition Mode X – Both Dipoles or Monopole Mode for Expert	OFF	
SAS2	STC Sonic Array Status – Upper Dipole	255	
SAS4	STC Sonic Array Status – Monopole P&S	255	
SBO2	STC Search Band Offset – Upper Dipole	3000	US
SBO4	STC Search Band Offset – Monopole P&S	500	US
SBR4	STC Baseline Removal – Monopole P&S	ON	
SBW2	STC Search Bandwidth – Upper Dipole	8000	US
SBW4	STC Search Bandwidth – Monopole P&S	2000	US
SFC2	STC Formation Character – Upper Dipole	SELECTABLE	
SFC4	STC Formation Character – Monopole P&S	SELECTABLE	
SFM2	STC Filter – Upper Dipole	B1-2K	
SFM4	STC Filter – Monopole P&S	B3-12K	
SHLL	Label Slowness Lower Limit – Monopole P&S Shear	235	US/F
SHUL	Label Slowness Upper Limit – Monopole P&S Shear	240	US/F
SLL2	STC Slowness Lower Limit – Upper Dipole	75	US/F
SLL4	STC Slowness Lower Limit – Monopole P&S	40	US/F
SST2	STC Slowness Step – Upper Dipole	4	US/F
SST4	STC Slowness Step – Monopole P&S	2	US/F
SSW2	STC Source Waveform – Upper Dipole	WF_SAM2	
SSW4	STC Source Waveform – Monopole P&S	WF_SAM4	

STLL	STC Slowness Lower Limit - Monopole Stoneley	180	US/F
STUL	Label Slowness Upper Limit - Monopole Stoneley	1200	US/F
SUL2	STC Slowness Upper Limit - Upper Dipole	1200	US/F
SUL4	STC Slowness Upper Limit - Monopole P&S	240	US/F
SWD2	STC Slowness Width - Upper Dipole	40	US/F
SWD4	STC Slowness Width - Monopole P&S	10	US/F
TBF2	STC Time for Baseline Fill - Upper Dipole	0	US
TBF4	STC Time for Baseline Fill - Monopole P&S	300	US
TLL2	STC Time Lower Limit - Upper Dipole	600	US
TLL4	STC Time Lower Limit - Monopole P&S	150	US
TST2	STC Time Step - Upper Dipole	200	US
TST4	STC Time Step - Monopole P&S	50	US
TUL2	STC Time Upper Limit - Upper Dipole	20200	US
TUL4	STC Time Upper Limit - Monopole P&S	3660	US
TWD2	STC Time Width - Upper Dipole	2000	US
TWD4	STC Time Width - Monopole P&S	1000	US
TWI2	STC Integration Time Window - Upper Dipole	1600	US
TWI4	STC Integration Time Window - Monopole P&S	500	US
TWSX	Transmitter Waveform Select X	0	
UTXG	Upper Dipole Transmitter Geometry	162	IN
WFM4	Waveform Mode 4	W1	
<b>HNGS-BA: Hostile Natural Gamma Ray Sonde</b>			
BAR1	HNGS Detector 1 Barite Constant	1	
BAR2	HNGS Detector 2 Barite Constant	1	
BHK	HNGS Borehole Potassium Correction Concentration	0	
BHS	Borehole Status	OPEN	
CSD1	Inner Casing Outer Diameter	0	IN
CSD2	Outer Casing Outer Diameter	0	IN
CSW1	Inner Casing Weight	0	LB/F
CSW2	Outer Casing Weight	0	LB/F
DBCC	HNGS Barite Constant Correction Flag	NONE	
GCSE	Generalized Caliper Selection	BS	
H1P	HNGS Detector 1 Allow/Disallow In Processing	ALLOW	
H2P	HNGS Detector 2 Allow/Disallow In Processing	ALLOW	
HABK	HNGS Borehole Potassium Running Average	-0.00178767	
HALF	HNGS Alpha Filter Length	60	IN
HCRB	HNGS Apply Borehole Potassium Correction	NONE	
HMWM	Mud Weighting Material	NATU	
HNPE	HNGS Processing Enable	YES	
S1BI	HNGS Detector 1 Calibration Bismuth Count Rate	1.3	CPS
S2BI	HNGS Detector 2 Calibration Bismuth Count Rate	1.3	CPS
SGRC	HNGS Standard Gamma-Ray Correction Flag	YES	
TPOS	Tool Position	CENT	
VBA1	HNGS Detector 1 Variable Barite Factor Running Average	1.04423	
VBA2	HNGS Detector 2 Variable Barite Factor Running Average	1.01776	
<b>EDTC-B: Enhanced DTS Cartridge</b>			
BHS	Borehole Status	OPEN	
GCSE	Generalized Caliper Selection	BS	
<b>System and Miscellaneous</b>			
BS	Bit Size	9.875	IN
DFD	Drilling Fluid Density	1.03	G/C3
DO	Depth Offset for Playback	-4251.0	M
PP	Playback Processing	NORMAL	

Format: DSST\_P\_S\_UPPER\_VDL\_COLOR      Vertical Scale: 1:200      Graphics File Created: 17-Mar-2014 14:28

### OP System Version: 19C0-187

MEST-B	19C0-187	DTA-A	8453
DSST-B	19C0-187	HNGC-B	19C0-187
HNGS-BA	19C0-187	EDTC-B	SKK-5169-EDTCB

### Input DLIS Files

DEFAULT	FMS_DSI_NGS_036PUP	FN:58	PRODUCER	18-Feb-2014 04:10	4672.6 M	4454.3 M
---------	--------------------	-------	----------	-------------------	----------	----------

### Output DLIS Files

DEFAULT	FMS_DSI_NGS_060PUP	FN:80	PRODUCER	17-Mar-2014 14:28
---------	--------------------	-------	----------	-------------------

### Calibration and Check Summary

Measurement	Nominal	Master	Before	After	Change	Limit	Units
-------------	---------	--------	--------	-------	--------	-------	-------

Before: Calibration out of date 4-Feb-2014 5:22								
Caliper 1 Zero Measurement	12.00	N/A	11.98	N/A	N/A	N/A	N/A	IN
Caliper 2 Zero Measurement	12.00	N/A	12.05	N/A	N/A	N/A	N/A	IN
Caliper 1 Plus Measurement	15.19	N/A	15.18	N/A	N/A	N/A	N/A	IN
Caliper 2 Plus Measurement	15.19	N/A	15.38	N/A	N/A	N/A	N/A	IN
Micro Electrical Scanner – B (Slim) Wellsite Calibration – CROUZET ACCELEROMETER				PROM HAS BEEN READ CORRECTLY				
Before: Calibration out of date 15-Feb-2014 0:36								
TEMPERATURE REFERENCE :	N/A	N/A	20	N/A	N/A	N/A	N/A	DEGC
YEAR OF CALIBRATION :	N/A	N/A	99	N/A	N/A	N/A	N/A	
MONTH OF CALIBRATION :	N/A	N/A	3	N/A	N/A	N/A	N/A	
SERIAL NUMBER :	N/A	N/A	743	N/A	N/A	N/A	N/A	
Micro Electrical Scanner – B (Slim) Wellsite Calibration – CROUZET MAGNETOMETER				PROM HAS BEEN READ CORRECTLY				
Before: Calibration out of date 15-Feb-2014 0:36								
TEMPERATURE REFERENCE :	N/A	N/A	23	N/A	N/A	N/A	N/A	DEGC
YEAR OF CALIBRATION :	N/A	N/A	3	N/A	N/A	N/A	N/A	
MONTH OF CALIBRATION :	N/A	N/A	9	N/A	N/A	N/A	N/A	
SERIAL NUMBER :	N/A	N/A	507	N/A	N/A	N/A	N/A	
Hostile Natural Gamma Ray Sonde Wellsite Calibration – Detector 1 Check								
Master: 4-Feb-2014 23:51 Before: 5-Feb-2014 0:02 After: 5-Feb-2014 0:07								
Na 511 Peak Loc	40.00	39.52	39.48	39.57	0.09216	1.000		
Na 511 Peak Res	15.50	15.96	16.77	17.05	0.2800	2.000		%
High Voltage	1150	1194	1193	1193	0.08801	N/A		V
Na 1785 Peak Loc	142.6	142.1	141.8	142.0	0.2398	7.000		
Na 1785 Peak Res	8.500	9.703	8.709	9.174	0.4646	2.000		%
Temperature	15.50	35.74	35.71	35.75	0.03577	N/A		DEGC
Na Count Rate	45.00	11.77	12.16	12.19	0.02500	8.000		CPS
Hostile Natural Gamma Ray Sonde Wellsite Calibration – Detector 2 Check								
Master: 4-Feb-2014 23:51 Before: 5-Feb-2014 0:02 After: 5-Feb-2014 0:07								
Na 511 Peak Loc	40.00	39.56	39.51	40.01	0.4946	1.000		
Na 511 Peak Res	15.50	16.07	16.56	16.11	-0.4463	2.000		%
High Voltage	1150	1126	1128	1128	0.1504	N/A		V
Na 1785 Peak Loc	142.6	142.3	143.1	142.2	-0.8427	7.000		
Na 1785 Peak Res	8.500	8.959	9.953	8.887	-1.065	2.000		%
Temperature	15.50	36.60	36.88	36.96	0.08454	N/A		DEGC
Na Count Rate	45.00	12.28	12.68	12.52	-0.1613	8.000		CPS
Hostile Natural Gamma Ray Sonde Wellsite Calibration – Ratio Of Detector 1 To Detector 2								
Master: 4-Feb-2014 23:51 Before: 5-Feb-2014 0:02 After: 5-Feb-2014 0:07								
Coincidence Count Rate Ratio	1.000	0.9624	0.9606	0.9690	0.008355	0.05000		
Hostile Natural Gamma Ray Sonde Master Calibration – Detector 1 Calibration								
Master: 4-Feb-2014 20:09								
Na 511 Peak Set Point	40.00	41.00	---	---	---	---		
Th Peak Loc	209.6	210.4	---	---	---	---		
Th Peak Res	7.000	7.207	---	---	---	---		%
Background Count Rate	142.5	16.20	---	---	---	---		CPS
Gain Ratio	1.000	1.012	---	---	---	---		
Hostile Natural Gamma Ray Sonde Master Calibration – Detector 2 Calibration								
Master: 4-Feb-2014 20:09								
Na 511 Peak Set Point	40.00	41.00	---	---	---	---		
Th Peak Loc	209.6	208.9	---	---	---	---		
Th Peak Res	7.000	7.337	---	---	---	---		%
Background Count Rate	142.5	16.52	---	---	---	---		CPS
Gain Ratio	1.000	1.004	---	---	---	---		
Enhanced DTS Cartridge Wellsite Calibration – EDTC Accelerometer Calibration								
Before: Calibration out of date 15-Feb-2014 0:36								
EDTC Z-Axis Acceleration	9.810	N/A	9.771	N/A	N/A	N/A	N/A	M/S2
Enhanced DTS Cartridge Wellsite Calibration – Detector Calibration								
Before: Calibration out of date 4-Feb-2014 5:11								
Gamma Ray (Jig – Bkg)	158.1	N/A	158.1	N/A	N/A	14.38		GAPI
Gamma Ray (Calibrated)	164.0	N/A	164.0	N/A	N/A	15.00		GAPI

Micro Electrical Scanner – B (Slim) / Equipment Identification

Primary Equipment:

MEST Sonde – B	MEDS – B	724
MEST Preamplifier Cartridge – AB	MEPC – AB	807
GPIT Cartridge – AC	GPIC – AC	840
MEST Acquisition Cartridge – A	MEAC – A	875

Auxiliary Equipment:

Hostile Natural Gamma Ray Cartridge - B / Equipment Identification

Primary Equipment: HNGC Cartridge	HNGC - B	300
Auxiliary Equipment: HNGC Housing	HNGH - A	115

Hostile Natural Gamma Ray Sonde / Equipment Identification

Primary Equipment: HNGS Sonde	HNGS - BA	194
Auxiliary Equipment: HNGS Sonde Housing Gamma Source Radioactive	HNSH - BA GSR - U	205 616008

Hostile Natural Gamma Ray Sonde Wellsite Calibration

Detector 1 Check

Phase	Na 511 Peak Loc	Value	Phase	Na 511 Peak Res %	Value	Phase	High Voltage V	Value
Master		39.52	Master		15.96	Master		1194
Before		39.48	Before		16.77	Before		1193
After		39.57	After		17.05	After		1193
	37.50 (Minimum) 40.00 (Nominal) 43.50 (Maximum)			12.00 (Minimum) 15.50 (Nominal) 19.00 (Maximum)			900.0 (Minimum) 1150 (Nominal) 1600 (Maximum)	
Phase	Na 1785 Peak Loc	Value	Phase	Na 1785 Peak Res %	Value	Phase	Temperature DEGC	Value
Master		142.1	Master		9.703	Master		35.74
Before		141.8	Before		8.709	Before		35.71
After		142.0	After		9.174	After		35.75
	135.0 (Minimum) 142.6 (Nominal) 150.3 (Maximum)			7.000 (Minimum) 8.500 (Nominal) 11.00 (Maximum)			-28.89 (Minimum) 15.50 (Nominal) 60.00 (Maximum)	
Phase	Na Count Rate CPS	Value						
Master		11.77						
Before		12.16						
After		12.19						
	10.00 (Minimum) 45.00 (Nominal) 100.0 (Maximum)							
Master: 4-Feb-2014 23:51			Before: 5-Feb-2014 0:02			After: 5-Feb-2014 0:07		

Hostile Natural Gamma Ray Sonde Wellsite Calibration

Detector 2 Check

Phase	Na 511 Peak Loc	Value	Phase	Na 511 Peak Res %	Value	Phase	High Voltage V	Value
Master		39.56	Master		16.07	Master		1126
Before		39.51	Before		16.56	Before		1128
After		40.01	After		16.11	After		1128
	37.50 (Minimum) 40.00 (Nominal) 43.50 (Maximum)			12.00 (Minimum) 15.50 (Nominal) 19.00 (Maximum)			900.0 (Minimum) 1150 (Nominal) 1600 (Maximum)	
Phase	Na 1785 Peak Loc	Value	Phase	Na 1785 Peak Res %	Value	Phase	Temperature DEGC	Value
Master		142.3	Master		8.959	Master		36.60
Before		143.1	Before		9.953	Before		36.88
After		142.2	After		8.887	After		36.96
	135.0 (Minimum) 142.6 (Nominal) 150.3 (Maximum)			7.000 (Minimum) 8.500 (Nominal) 11.00 (Maximum)			-28.89 (Minimum) 15.50 (Nominal) 60.00 (Maximum)	
Phase	Na Count Rate CPS	Value						
Master		12.28						

Before		12.68
After		12.52
	10.00 (Minimum)      45.00 (Nominal)      100.0 (Maximum)	

Master: 4-Feb-2014 23:51      Before: 5-Feb-2014 0:02      After: 5-Feb-2014 0:07

Hostile Natural Gamma Ray Sonde Wellsite Calibration		
Ratio Of Detector 1 To Detector 2		
Phase	Coincidence Count Rate Ratio	Value
Master		0.9624
Before		0.9606
After		0.9690
	0.9500 (Minimum)      1.000 (Nominal)      1.050 (Maximum)	

Master: 4-Feb-2014 23:51  
Before: 5-Feb-2014 0:02  
After: 5-Feb-2014 0:07

Hostile Natural Gamma Ray Sonde Master Calibration									
Detector 1 Calibration									
Phase	Na 511 Peak Set Point			Value	Phase	Th Peak Loc			Value
Master				41.00	Master				210.4
	38.00 (Minimum)	40.00 (Nominal)	43.00 (Maximum)			201.0 (Minimum)	209.6 (Nominal)	218.3 (Maximum)	
Phase	Background Count Rate CPS			Value	Master	Th Peak Res %			Value
Master				16.20	Master				7.207
	10.00 (Minimum)	142.5 (Nominal)	265.0 (Maximum)			5.000 (Minimum)	7.000 (Nominal)	9.000 (Maximum)	
Phase	Gain Ratio			Value	Master	Gain Ratio			Value
Master				1.012	Master				1.012
	0.9400 (Minimum)	1.000 (Nominal)	1.060 (Maximum)			0.9400 (Minimum)	1.000 (Nominal)	1.060 (Maximum)	

Master: 4-Feb-2014 20:09

Hostile Natural Gamma Ray Sonde Master Calibration									
Detector 2 Calibration									
Phase	Na 511 Peak Set Point			Value	Phase	Th Peak Loc			Value
Master				41.00	Master				208.9
	38.00 (Minimum)	40.00 (Nominal)	43.00 (Maximum)			201.0 (Minimum)	209.6 (Nominal)	218.3 (Maximum)	
Phase	Background Count Rate CPS			Value	Master	Th Peak Res %			Value
Master				16.52	Master				7.337
	10.00 (Minimum)	142.5 (Nominal)	265.0 (Maximum)			5.000 (Minimum)	7.000 (Nominal)	9.000 (Maximum)	
Phase	Gain Ratio			Value	Master	Gain Ratio			Value
Master				1.004	Master				1.004
	0.9400 (Minimum)	1.000 (Nominal)	1.060 (Maximum)			0.9400 (Minimum)	1.000 (Nominal)	1.060 (Maximum)	

Master: 4-Feb-2014 20:09

Enhanced DTS Cartridge / Equipment Identification			
Primary Equipment:			
EDTC Gamma Ray Detector	EDTG - A/B	8305	
Enhanced DTS Cartridge	EDTC - B	8317	
Auxiliary Equipment:			
EDTC Housing	EDTH - B	8303	

Enhanced DTS Cartridge Wellsite Calibration			
EDTC Accelerometer Calibration			
Phase	EDTC Z-Axis Acceleration M/S2	Value	
Before		9.771	
	9.610 (Minimum)	9.810 (Nominal)	10.01 (Maximum)

Before: Calibration out of date 15-Feb-2014 0:36

Enhanced DTS Cartridge Wellsite Calibration							
Detector Calibration							
Phase	Gamma Ray Background GAPI		Value	Phase	Gamma Ray (Jig - Bkg) GAPI		Value
Before			1.000	Before			1.000
	0.9500 (Minimum)	1.000 (Nominal)	1.050 (Maximum)		0.9500 (Minimum)	1.000 (Nominal)	1.050 (Maximum)
Phase	Gamma Ray (Calibrated) GAPI		Value	Before	Gamma Ray (Calibrated) GAPI		Value
Before			1.000	Before			1.000
	0.9500 (Minimum)	1.000 (Nominal)	1.050 (Maximum)		0.9500 (Minimum)	1.000 (Nominal)	1.050 (Maximum)

Before		6.615	Before		158.1	Before		164.0
0 (Minimum)	30.00 (Nominal)	120.0 (Maximum)	143.8 (Minimum)	158.1 (Nominal)	172.5 (Maximum)	149.0 (Minimum)	164.0 (Nominal)	179.0 (Maximum)
Before: Calibration out of date 4-Feb-2014 5:11								

Company: **Lamont Doherty Earth Observatory**

**Schlumberger**

Well: **Expedition 349, Site U1431**  
 Field: **South China Sea Tectonics**  
 Rig: **JOIDES Resolution**  
 Ocean: **South China Sea**

Dipole Shear Sonic Imager (DSI)  
 Upper/Lower Dipole Shear  
 Monopole Compressional and GR